

Condensatori serie 4.16.04 custodia plastica

Capacitors series 4.16.04 plastic case



Il dielettrico è in film di polipropilene, le armature sono costituite da un sottilissimo deposito metallico ottenuto per evaporazione sotto vuoto.

Custodia e coperchio sono realizzati in materiale plastico autoestinguente; l'elemento capacitivo bloccato con resina poliuretanic.

Le caratteristiche principali di queste serie di condensatori sono:

- Avvolgimento antinduttivo a basse perdite
- Proprietà autorigeneranti che impediscono il cortocircuito
- Piccole dimensioni e peso contenuto
- Il condensatore è del tipo "a secco" e non presenta quindi rischi di perdite.

Sicurezza

Sappiamo che le condizioni che determinano il corto-circuito sono due, singolarmente o in combinazione fra loro: forti sovratensioni o temperatura eccessiva.

Le due condizioni si influenzano a vicenda: una forte sovratensione produce una forte sovracorrente, un surriscaldamento dei collegamenti interni e, di conseguenza anche un aumento della temperatura del condensatore. Viceversa, una temperatura elevata determina un rapido invecchiamento e deterioramento del dielettrico, abbassandone la rigidità (soglia di tensione alla quale avviene la perforazione). Il dimensionamento del condensatore è tale da impedire il raggiungimento anche di una sola delle due condizioni di rischio citate o di una loro combinazione.

The dielectric is polypropylene film, the electrodes consist of an extremely thin metal coating obtained by vacuum evaporation.

Case and cover are made with self-extinguishing plastic material, the capacitive element is sealed with polyurethane resin.

The main characteristics of these capacitors are

- *Low losses non-inductive winding*
- *Self-healing property avoiding short circuits*
- *Small size and limited weight*
- *Dry technology no leakage risk.*

Safety

We know that short-circuits may result from two causes either individually or in combination: high overvoltages or excessively high temperatures.

The two conditions affect each other: a high overvoltage produces a high overcurrent, overheating of the internal connections, and thus also an increase in the capacitor temperature. On the other hand, a high temperature leads to rapid ageing and deterioration of the dielectric, reducing its rigidity (the voltage threshold at which perforation occurs). The capacitors is rated so that it will not reach even just one of the two risk conditions or a combination of them.

CARATTERISTICHE TECNICHE

Tensione nominale	: 250 V~ - 50/60 Hz 280 V~ - 50 Hz
Temperatura di lavoro	: -25... +85°C
Angolo di perdita	: $\tan\delta \leq 20 \cdot 10^{-4}$ (20°C, Vn, 50 Hz)
Resistenza di scarica	: 1 M Ω \leq 22 μ F 300 k Ω 25 \div 70 μ F 220 k Ω 80 \div 100 μ F
Tensione di prova	: Tra le armature: 2,Un per 2 sec. verso massa: 2 kV per 60 sec. (prova di tipo)
Omologazioni	: 
Norme di riferimento	: EN 61048/A1/A2 tipo A - EN 61049
Rivestimento	: Custodia e coperchio in materiale plastico autoestinguente
Terminali	: Terminali ad innesto 2,8 mm ² Cavetti unipolari rigidi isolati in PVC 90°C 0,5 mm ² - con morsettiera integrata
Grado di protezione	: IP00
Tolleranza di capacit�	: \pm 10%

TECHNICAL CHARACTERISTICS

Rated voltage	: 250 V~ - 50/60 Hz 280 V~ - 50 Hz
Working temperature	: -25... +85°C
Dissipation factor	: $\tan\delta \leq 20 \cdot 10^{-4}$ (20°C, Vn, 50 Hz)
Discharge resistor	: 1 M Ω \leq 22 μ F 300 k Ω 25 \div 70 μ F 220 k Ω 80 \div 100 μ F
Test voltage	: Between terminals: 2,Un for 2 sec. between terminal and case: 2 kV for 60 sec. (type test)
Approvals	: 
Reference standards	: EN 61048/A1/A2 type A - EN 61049
Protection	: Case and cover in self-extinguishing plastic material
Terminals	: Plug-in terminals 2.8 mm ² Insulated solid core leads in PVC 90°C 0.5 mm ² - push wire connection
Protection degree	: IP00
Capacitance tolerance	: \pm 10%

Modelli standard / Standard values (°)

4.16.04

Con morsettiera integrata With integrated push wire					Con terminali faston 2,8 mm e cavetti With 2,8 mm tags and leads				
Capacit� Capacitance	Codice Part number	Dim. DxH	Conf. n. pz per scatola Packages n. pcs x box (•)	D ^Δ	Capacit� Capacitance	Codice Part number	Dim. DxH	Conf. n. pz per scatola Packages n. pcs x box (•)	D ^Δ
μ F	4.16.04.xx.kk	mm			μ F	4.16.04.xx.kk	mm		
2	4.16.04.C4.kk	25x50	250	B	2	4.16.04.C4.kk	25x50	200	B
2,5	.C5.	»	»	»	2,5	.C5.	»	»	»
3	.C6.	»	»	»	3	.C6.	»	»	»
3,15	.C7.	»	»	»	3,15	.C7.	»	»	»
3,5	.C8.	»	»	»	3,5	.C8.	»	»	»
4	.C9.	»	»	»	4	.C9.	»	»	»
4,5	.D1.	25x55	»	»	4,5	.D1.	25x55	125	A
5	.D2.	»	»	»	5	.D2.	»	»	»
6	.D3.	25x70	200	B	6	.F5.	30x56	100	B
6,3	.D4.	»	»	»	6,3	.F6.	»	»	»
7	.D5.	»	»	»	7	.F7.	»	»	»
8	.D6.	30x70	125	A	8	.D6.	30x70	100	B
9	.D7.	»	»	»	9	.D7.	»	»	»
10	.D8.	»	»	»	10	.D8.	»	»	»
12	.D9.	»	»	»	12	.A1.	36x70	50	A
12,5	.E1.	30x92	100	B	12,5	.A2.	»	»	»
14	.E2.	»	»	»	14	.A3.	»	»	»
15	.E3.	»	»	»	15	.A4.	»	»	»
16	.E4.	»	»	»	16	.A5.	»	»	»
18	.E5.	»	»	»	18	.A6.	40x70	50	A
20	.E6.	35x92	50	A	20	.A7.	»	»	»
22	.E7.	»	»	»	22	.A8.	40x92	50	B
25	.E8.	»	»	»	25	.A9.	»	»	»
30					30	.B1.	»	»	»
31,5					31,5	.B2.	»	»	»
35					35	.B3.	45x92	25	A
40					40	.B4.	»	»	»
45					45	.B5.	»	»	»
50					50	.B6.	45x117	25	A
60					60	.B7.	»	»	»
70*					70*	.B8.	50x117	25	B
80*					80*	.B9.	55x120	25	B
100*					100*	.C1.	60x120	20	B

* Non approvati/Not approved
(•) Peso scatola/Box weight dim. A = 8 \div 9 kg
dim. B = 7,5 \div 8 kg

D^Δ Dimensioni scatola:
Standard box dimensions
A = mm 195 x 390 x 200
B = mm 195 x 390 x 255

(°) Disponibili altre dimensioni
Other dimensions available

Soluzioni meccaniche / Mechanical configurations

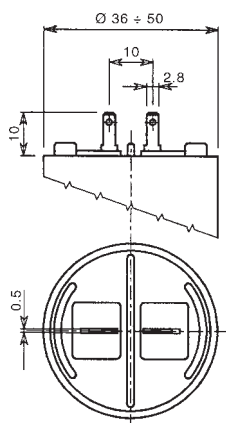

Fig. 1. Faston 2,8 x 0,5 mm
Fig. 1. Tags 2.8 x 0,5 mm

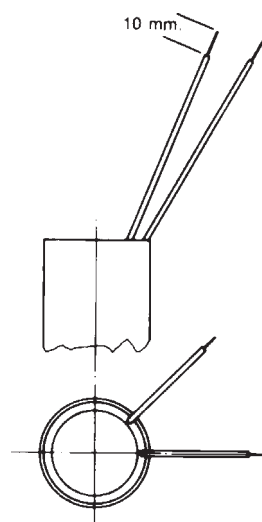

Fig. 2. Cavetti unipolari 0,5 mm²
 L = 250 mm
Fig. 2. Insulated solid core leads 0.5 mm²
 L = 250 mm

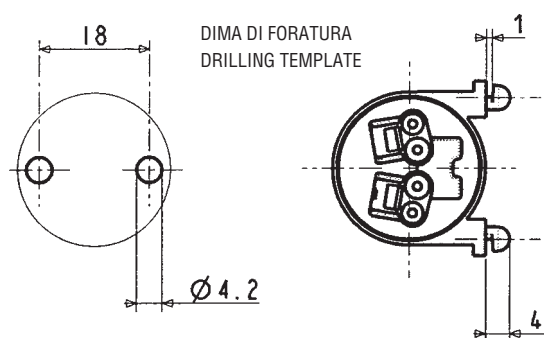

Fig. 3. Morsettiera integrata.
Fig. 3. Push wire connection.

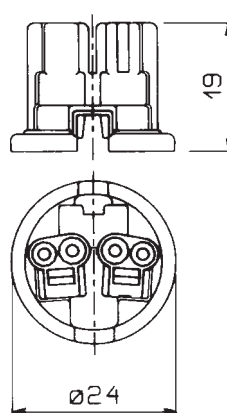





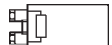

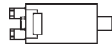
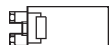

Fig. 4. Morsettiera isolante a innesto, completa di resistore di scarica.
Fig. 4. Insulating push wire connector, complete with discharge resistor.

Tab. 1 - Accessori (kk)
Tab. 1 - Accessories (kk)

Fig. 1 Terminali ad innesto 2,8 mm. P 10 mm		00
Fig. 1 Plug-in terminals 2,8 mm. P 10 mm		40
Fig. 2 Cavetti unipolari L=250 mm		07
Fig. 2 Unipolar leads L=250 mm		47
Fig. 2 Cavetti unip. con pied. per innesto rapido Unipolar leads L=250 mm, captive feet		43
Da 2 a 22 µF - From 2 to 22 µF		
Fig. 3 Morsettiera con codolo Push wire with stud		23
Fig. 3 Morsettiera senza codolo Push wire without stud		18
Fig. 3 Morsettiera con pied. per innesto rapido Push wire, captive feet		21
Da 12 a 100 µF - From 12 to 100 µF		
Fig. 4 Morsettiera (non montata) Fig. 4 Push wire connector (unmounted)	Codice 316.23.1000 Part number 316.23.1000	
Morsettiera con codolo Push wire with stud		25
Morsettiera senza codolo Push wire without stud		20