



LIGHT KIT MAIN INCASSO 2 METRI



Codice prodotto	Colore
7512-20-30	Nero
7512-20-31	Bianco
7512-20-42	Anodizzato naturale

Specifiche generali

Tipo di prodotto	: Binari
Tipo di montaggio	: Incasso da soffitto
Descrizione	: Binario trifase
Luci per interni/esterni	: Interni

Specifiche elettriche

Corrente (A)	: 16
Tensione (V)	: 230/440

Dimensioni e peso

Lunghezza (mm)	: 2000
Larghezza (mm)	: 53
Profondità incasso (mm)	: 37

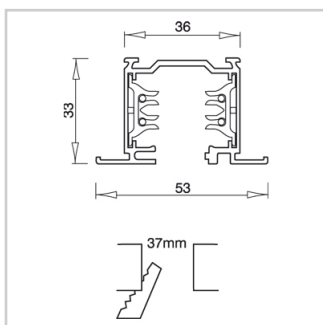

Accessori

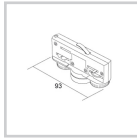

7600-00-20/30/31
Adattatore
elettromeccanico

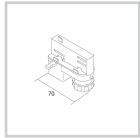

7601-00-W20/30/31
Adattatore
elettromeccanico

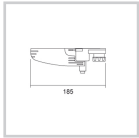

7601-11-30/31
Adattatore



7604-10-W30/31
Giunto lineare
con contatti

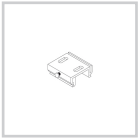

7607-00-00
Kit attacco
soffitto

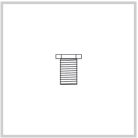

7609-00-00
Raccordo

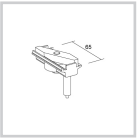

7618-00-30/31/52
Adattatore
meccanico
con
bloccacavo

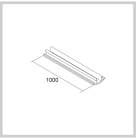

7624-00-30/31
Copertura
binario

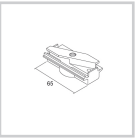

7625-00-30/31/52
Adattatore
meccanico



7654-10-W30/31
Giunto lineare
senza contatti



76591-00-W20/30/31
Terminale di
chiusura



7662-10-W20/30/31
Alimentazione
e destra

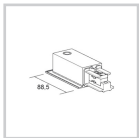

7662-11-W20/30/31
Alimentazione
e sinistra

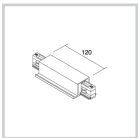

7663-10-W20/30/31
Alimentazione
e centrale e
giunto lineare



7664-00-48
Sospensione
per
controsoffitto

Immagini e Applicazioni

