

VIDEOCITOFONO A COLORI 2VOICE
2VOICE COLOUR VIDEO DOOR PHONE
VIDEOPHONE COULEURS 2VOICE
VIDEOINTERFONO COLOR 2VOICE
FARB-VIDEOANLAGE 2VOICE

Sch./Ref.1750/1

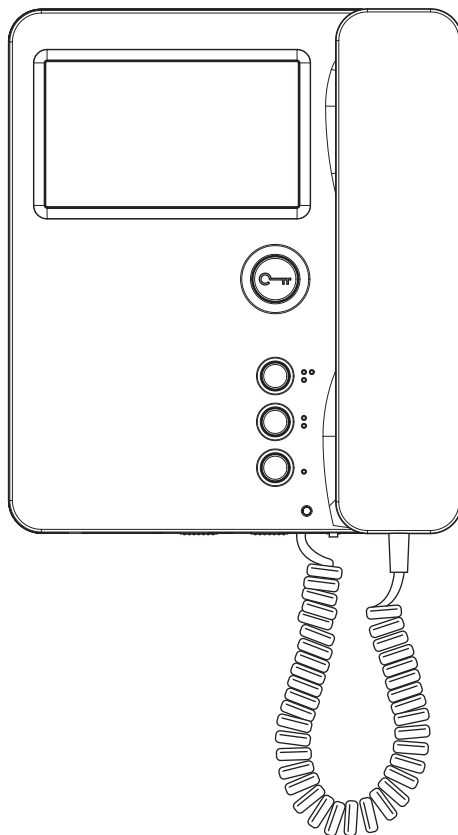

ITALIANO

Il videocitofono Sch.1750/1 è dedicato all'utilizzo in impianti videocitofonici del sistema 2Voice.

DESCRIZIONE DEI COMPONENTI E CARATTERISTICHE

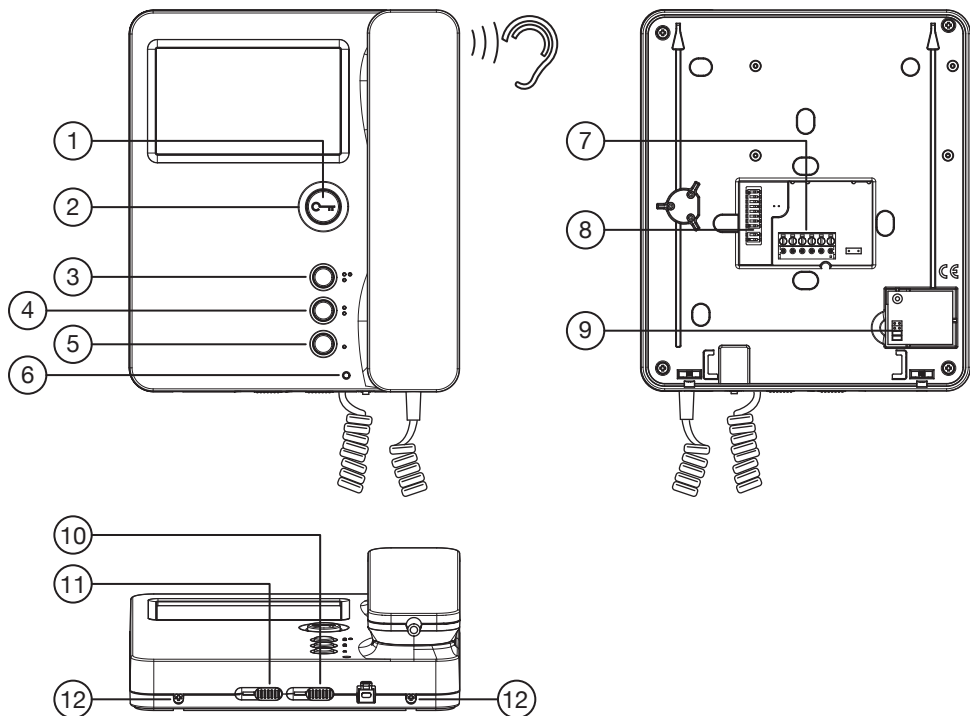

1. Tasto apriporta
2. Led verde presente sotto al tasto apriporta
3. Pulsante
4. Pulsante
5. Pulsante
6. Led bicolore
7. Morsetti per collegamento al sistema
8. Dip-switch di configurazione:
 - a. 2 per definire il numero del posto interno all'interno dell'appartamento
 - b. 8 per definire il numero dell'appartamento nella colonna

Per le impostazioni dei dip-switch fare riferimento al libretto di sistema

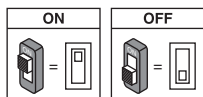

9. Predisposizione per collegamento entra-esce con accessorio Sch. 1750/50
10. Luminosità
11. Colore
12. Viti di bloccaggio del videocitofono alla staffa



Posizionare il selettore in modalità T.

Dispositivo compatibile con tutte le protesi acustiche con modalità di funzionamento T (Norme ETS 300381 e EN 60118).

DESCRIZIONE DEI MORSETTI



⊗]	LINE IN	Connessione al BUS di sistema
⊗			
⊗]	CP	Chiamata al piano
⊗			
⊗	}	S+	Ripetizione di chiamata
⊗			

INSTALLAZIONE

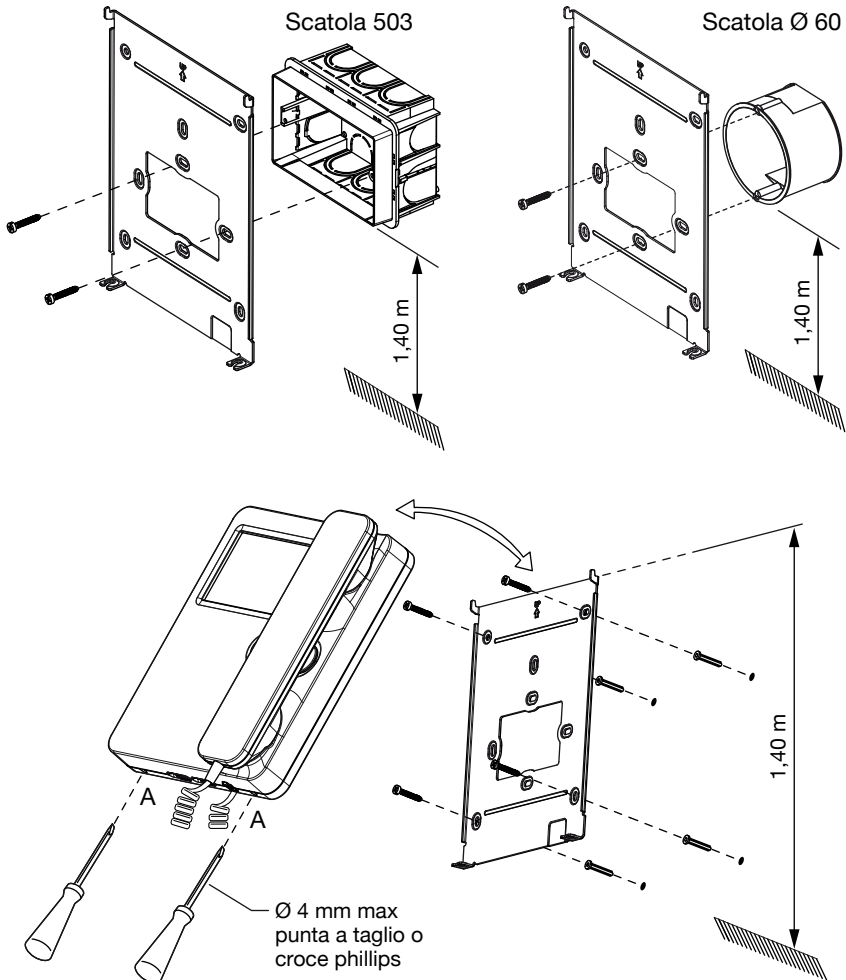
- Fissare la staffa a parete utilizzando una scatola 503 e le viti in dotazione o una scatola Ø 60 con viti adeguate.
- Programmare i dip-switch di programmazione.
- Collegare alla morsetti i conduttori provenienti dall'impianto.
- Agganciare il monitor alla staffa e bloccarlo avvitando le viti A di fissaggio.



FUNZIONE PULSANTI

STATO PULSANTE	RIPOSO E AGGANCIATO	ATTESA SGANCIO (ricezione chiamata)	IN FONIA	RIPOSO E SGANCIATO	STATO DI PROGRAMMAZIONE* (SOLO CON VIDEOCITOFONO A RIPOSO E AGGANCIATO)
	Apriporta pedonale	Apriporta pedonale	Apriporta pedonale	Apriporta pedonale	Abilita/disabilita apriporta automatico
	Scorrimento memoria video	Funzione speciale (default: 7)	Funzione speciale (default: 7)	Chiamata intercomunicante 3 programmabile (default: non programmato)	Regolazione volume di chiamata citofonica e al piano (il volume cambia secondo la sequenza ALTO,BASSO,MUTE)
	Autoinserzione	Palleggiamento video	Funzione speciale (default: 8)	Chiamata intercomunicante 2 programmabile (default: non programmato)	Scelta suoneria chiamata al piano (5 suonerie diverse)
	Apriporta passo carraio	Apriporta passo carraio	Apriporta passo carraio	Chiamata intercomunicante 1 programmabile (default: chiamata a centralino)	Scelta suoneria chiamata citofonica (5 suonerie diverse)

(*) Per entrare o uscire dallo stato di programmazione premere e tenere premuto il tasto ● per più di 5 secondi; la conferma dell'entrata in programmazione avviene con il lampeggio lento del led giallo; comunque allo scadere della temporizzazione di 10 min si esce dallo stato di programmazione.

SEGNALAZIONI LED

2. Led verde acceso.
Segnala la ricezione di una chiamata.

6. Led bicolore.

PRIORITÀ	FUNZIONI
1	Rosso lampeggiante veloce: mute attivo
2	Verde lampeggiante: apriporta automatico attivo
3	Rosso acceso fisso: porta aperta sul posto di chiamata principale
4	Rosso lampeggiante lento: porta aperta sul posto di chiamata secondario
5	Giallo lampeggiante lento: stato di programmazione attivo

 Per salvare la programmazione ricordarsi di uscire dalla stessa tenendo premuto il tasto ● per più di 5 secondi; comunque trascorsi 10 minuti il dispositivo esce dallo stato di programmazione salvando i parametri variati.
Per la programmazione della chiamata intercomunicante fare riferimento al libretto di sistema.

RESET





Per ripristinare i parametri di default del dispositivo, dopo l'ingresso in programmazione con la pressione del tasto ● per più di 5 secondi, premere contemporaneamente i tasti ● e  per più di 3 secondi; la conferma del comando avviene con l'emissione di 2 beep lunghi e l'uscita del dispositivo dallo stato di programmazione.

ENGLISH

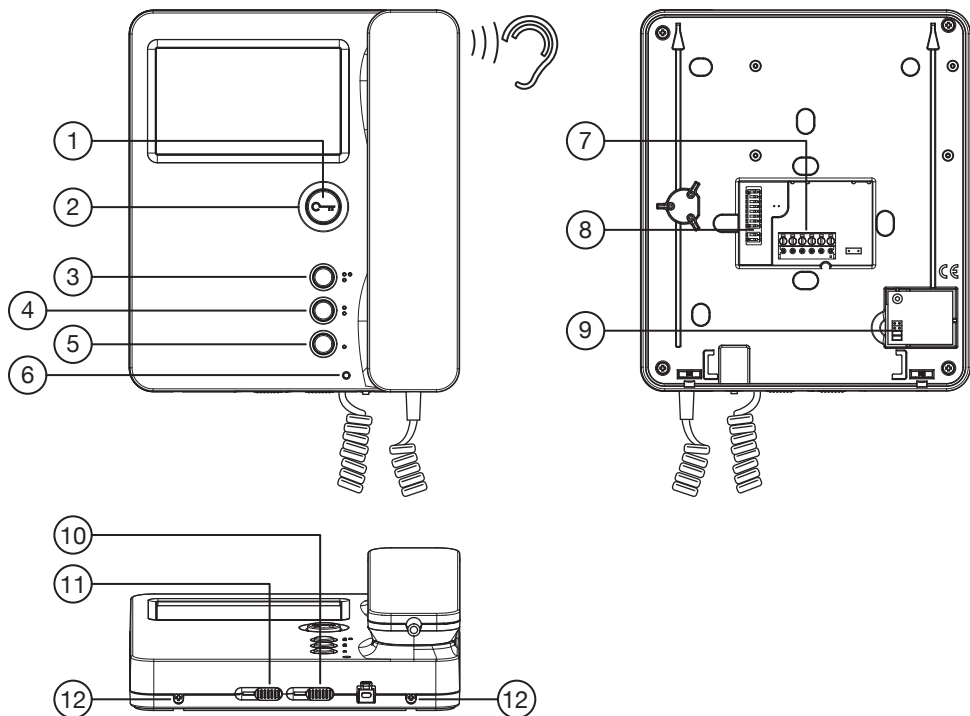
The Ref.1750/1 video door phone is dedicated to the 2Voice system video door phones.

DESCRIPTION OF COMPONENTS AND FEATURES



1. Door opener button 
2. Green LED under door opening button
3. Button 
4. Button 
5. Button 
6. Two-colour LED
7. Terminals for connecting to the system
8. Configuration dip switch:
 - a. 2 to define the station number in the apartment
 - b. 8 to define the apartment number in the column

9. In-out connection setup with Ref. 1750/50
10. Brightness
11. Colour
12. Screws for fixing video door phone to bracket

 Refer to the system booklet for how to set the dip switches.

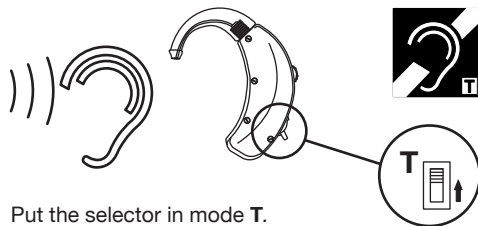
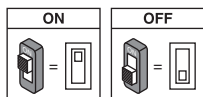

Put the selector in mode T.

 Device compatible with all hearing aids with operating mode T (Standards ETS 300381 and EN 60118).

DESCRIPTION OF TERMINALS



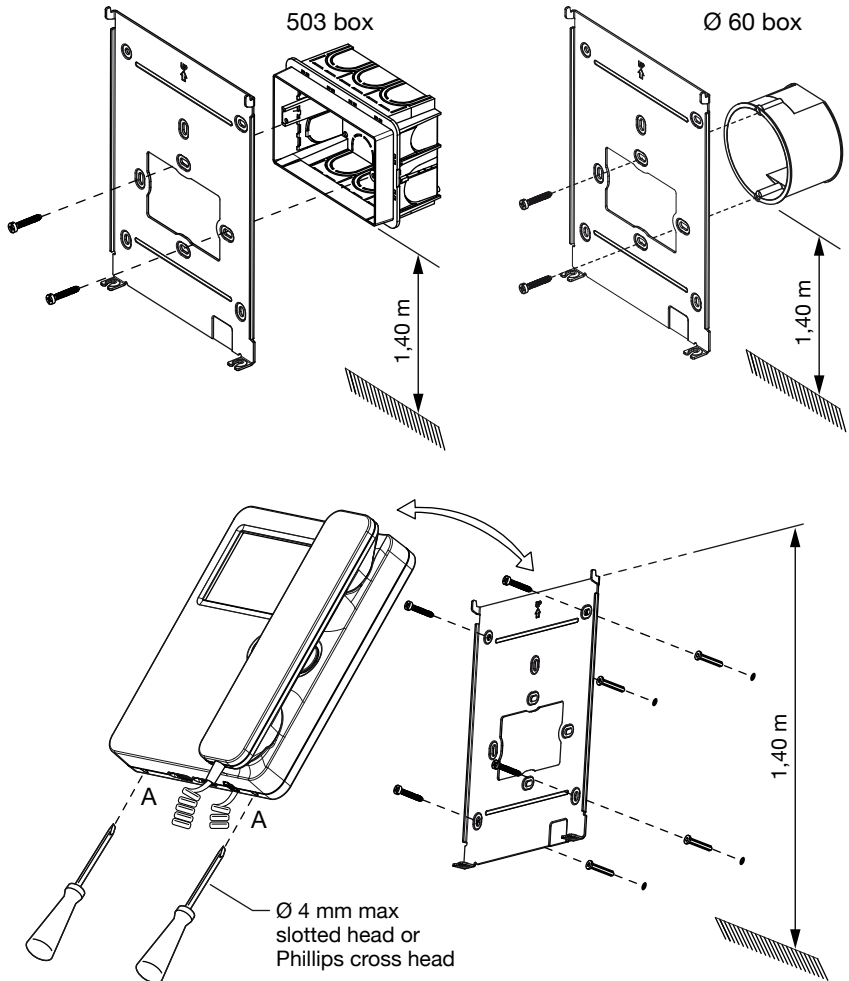

⊘] LINE IN	System bus connection
⊘		
⊘] CP	Floor call
⊘		
⊘	} S+	Call repetition
⊘		

INSTALLATION

- Fix the bracket to the wall using a box 503 and the screws provided or a Ø 60 box with suitable screws.
- Program the dip switches.
- Connect the wires from the system to the terminal board.
- Couple the monitor to the bracket and lock it by screwing fastening screws A.



BUTTON FUNCTIONS

STATE BUTTON	STANDING BY ON-HOOK	RINGING ON-HOOK (RECEIVING CALL)	DURING AUDIO OPERATION	STANDING BY OFF-HOOK	PROGRAMMING STATE* (WITH VIDEO DOOR PHONE STANDING BY ON-HOOK)
	Open pedestrian door	Open pedestrian door	Open pedestrian door	Open pedestrian door	Connect / disconnect the automatic door opening system
	Scroll video memory	Special function (default: 7)	Special function (default: 7)	Programmable intercom call 3 (Default: not programmed)	Adjust door phone and floor call volume (volume changes according to the following sequence: LOUD, LOW, MUTE)
	Auto power-on	Video switching	Special function (default: 8)	Programmable intercom call 2 (Default: not programmed)	Floor call ring tone (5 different ring tones)
	Garage door opener	Garage door opener	Garage door opener	Programmable intercom call 1 (Default: switchboard call)	Door phone call ring tone (5 different ring tones)

(*) To enter and exit programming state, hold button ● pressed for longer than 5 seconds. The yellow LED will blink slowly to indicate that programming mode is selected. Programming mode will shut down in all cases after the 10 minute timeout.

INDICATOR LEDS

- Green LED on.
Indicates that a call is being received
- Two-colour LED.

PRIORITY	FUNCTIONS
1	Rapidly blinking red: mute on
2	Green blinking: automatic door opener on
3	Red on steady: main calling station door open
4	Slowly blinking red: secondary calling station door open
5	Slowly blinking yellow: programming state on

 To save programming, remember to hold the button ● pressed for longer than 5 seconds to quit programming mode. In any case, after 10 minutes the system exits the programming state and saves the modified parameters.
Refer to the system booklet for how to program intercom calls.

RESET

To restore default parameters of the device after entering programming mode, hold button ● pressed for longer than 5 seconds, hold buttons ● and  pressed for longer than 3 seconds. The system will emit two long beeps to confirm the command and exit the programming state.

FRANÇAIS

Le vidéophone Réf.1750/1 est conçu pour être utilisé dans les installations de vidéophonie du système 2Voice.

DESCRIPTION DES COMPOSANTS ET CARACTERISTIQUES

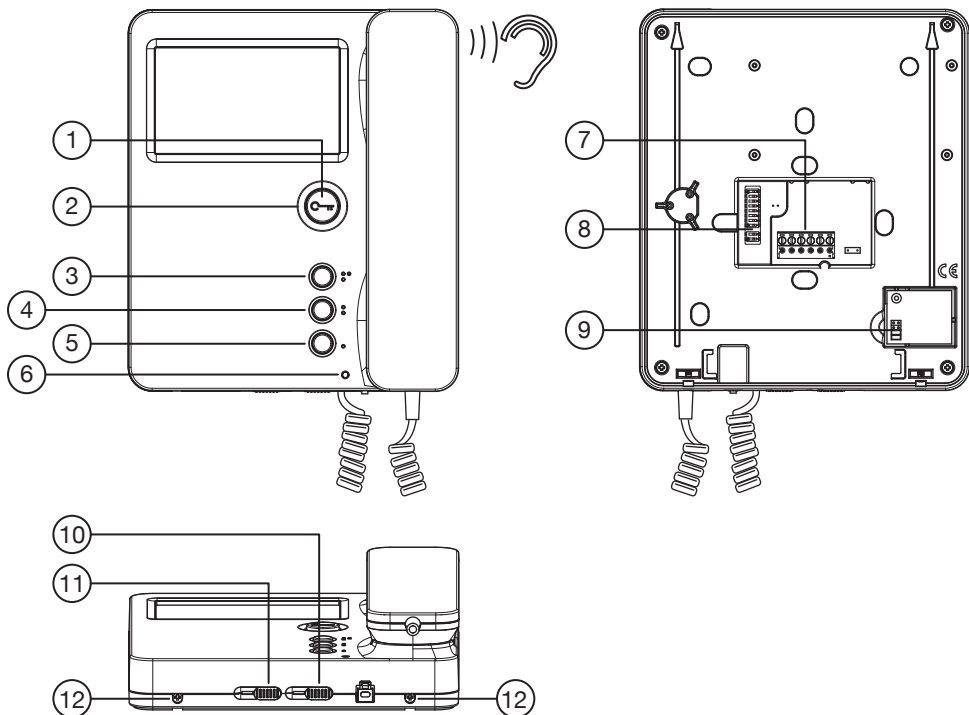

1. Touche ouvre-porte
2. LED verte située sous la touche ouvre-porte
3. Bouton
4. Bouton
5. Bouton
6. LED bicolore
7. Bornes de connexion au système
8. Commutateur de configuration:
 - a. 2 pour définir le numéro du poste interne dans l'appartement
 - b. 8 pour définir le numéro de l'appartement dans la colonne

9. Pré-câblage pour le raccordement entrée-sortie avec accessoire Réf. 1750/50
10. Luminosité
11. Couleur
12. Vis de fixation du vidéophone à l'étrier

Pour les réglages des commutateurs, se reporter à la notice de système.

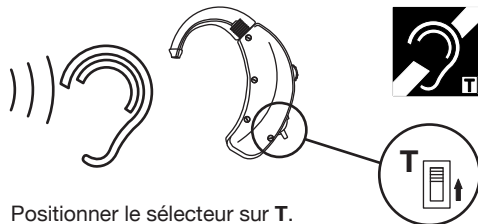
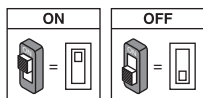

Positionner le sélecteur sur T.

Dispositif compatible avec les prothèses auditives avec mode de fonctionnement T (Dispositions ETS 300381 et EN 60118).

DESCRIPTION DES BORNES



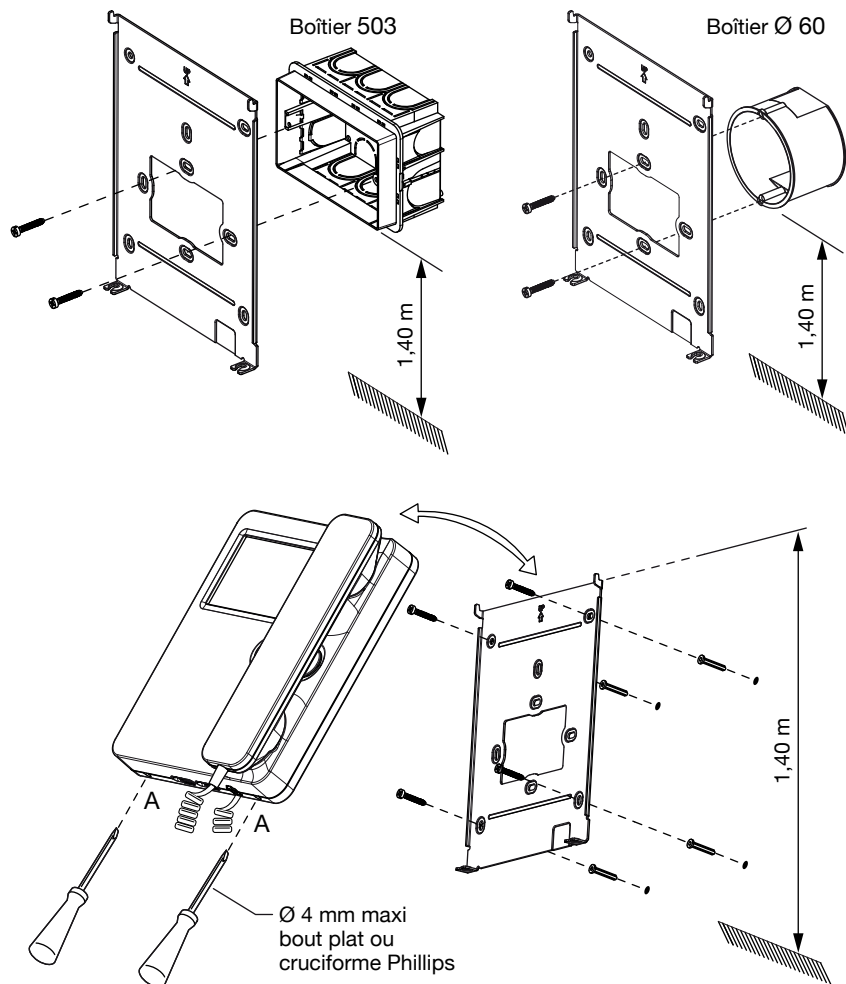

○] LINE IN	Connexion au BUS de système
○		
○] CP	Appel à l'étage
○		
○	} S+	Répétition appel
○		

INSTALLATION

- Fixer l'étrier à la paroi en utilisant un boîtier 503 et les vis livrées de série, ou bien un boîtier Ø 60 avec des vis appropriées.
- Régler les commutateurs de programmation.
- Brancher les connecteurs en provenance de l'installation sur le bornier.
- Accrocher l'écran à l'étrier et le bloquer en vissant les vis de fixation A.



FONCTIONS DES BOUTONS

ETAT BOUTON	REPOS ET RACCROCHAGE	ATTENTE DECROCHAGE (RECEPTION APPEL)	PHONIE	REPOS ET DECROCHAGE	ETAT DE PROGRAMMATION (*) (VIDEOPHONE AU REPOS ET RACCROCHE)
	Ouvre-porte piétons	Ouvre-porte piétons	Ouvre-porte piétons	Ouvre-porte piétons	Activation/désactivation ouvre-porte automatique
	Défilement mémoire vidéo	Fonction spéciale (par défaut: 7)	Fonction spéciale (par défaut: 7)	Appel intercom 3 programmable (par défaut: non programmé)	Réglage du volume d'appel d'interphone et à l'étage (le volume varie selon la séquence HAUT, BAS, MUTE)
	Activation automatique	Renvoi vidéo	Fonction spéciale (par défaut: 8)	Appel intercom 2 programmable (par défaut: non programmé)	Sélection sonnerie d'appel à l'étage (5 sonneries différentes)
	Ouverture passage pour véhicules	Ouverture passage pour véhicules	Ouverture passage pour véhicules	Appel intercom 1 programmable (par défaut: appel vers centrale)	Sélection sonnerie d'appel d'interphone (5 sonneries différentes)

(*) Pour accéder ou quitter l'état de programmation, maintenir le bouton ● enfoncé pendant plus de 5 secondes; le clignotement lent de la LED jaune confirme l'accès à la programmation. Au bout de 10 minutes, le système quitte automatiquement l'état de programmation.

SIGNALISATIONS PAR LED

- LED verte allumée.
Signale la réception d'un appel.
- LED bicolore.

PRIORITE	FONCTIONS
1	Rouge, clignotement rapide: fonction Mute active
2	Vert, clignotement: ouvre-porte automatique actif
3	Rouge, lumière fixe: porte ouverte sur poste d'appel principal
4	Rouge, clignotement lent: porte ouverte sur poste d'appel secondaire
5	Jaune, clignotement lent: état de programmation actif

 Pour enregistrer la programmation, quitter celle-ci en maintenant le bouton ● enfoncé pendant plus de 5 secondes. Au bout de 10 minutes, le dispositif quitte en tout cas l'état de programmation, en enregistrant les paramètres modifiés.
Pour la programmation de l'appel intercom, se reporter à la notice de système.

RESET

Pour rétablir les paramètres par défaut du dispositif, après l'accès à la programmation en maintenant le bouton ● enfoncé pendant plus de 5 secondes, appuyer en même temps sur les boutons ● et  pendant plus de 3 secondes; la commande est confirmée par l'émission de 2 bips sonores prolongés et par la sortie du dispositif de l'état de programmation.

El videointerfono Ref. 1750/1 está destinado al uso en instalaciones videointerfónicas del sistema 2Voice.

DESCRIPCIÓN DE LOS COMPONENTES Y CARACTERÍSTICAS

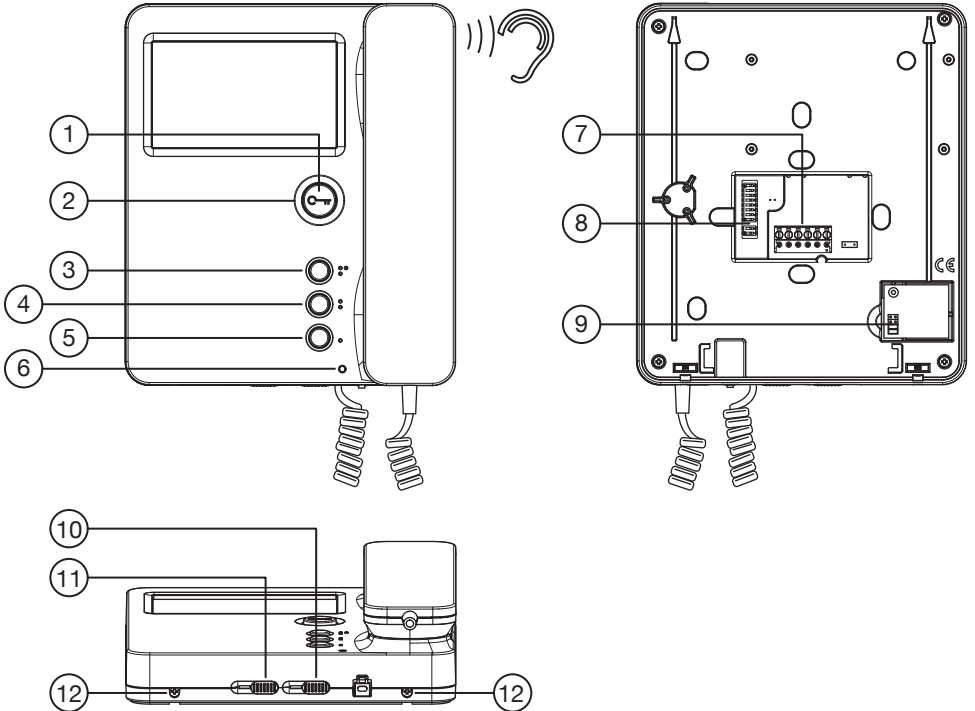

1. Tecla de apertura de la puerta
2. Led verde presente debajo de la tecla de apertura de la puerta
3. Pulsador
4. Pulsador
5. Pulsador
6. Led bicolor
7. Bornes para la conexión al sistema
8. Interruptor dip de configuración:
 - a. 2 para definir el número del aparato interior dentro del apartamento
 - b. 8 para definir el número del apartamento en la columna

9. Preparación para la conexión entrar-salir de accesorio Ref. 1750/50
10. Brillo
11. Color
12. Tornillos de bloqueo del videointerfono en el soporte

Para las configuraciones de los interruptores dip, consultar el manual de sistema.

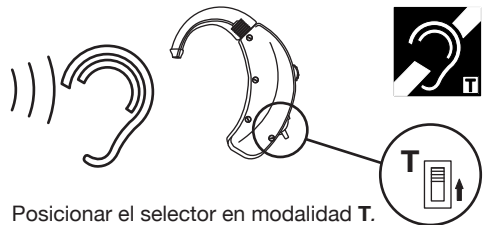
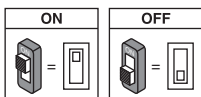

Posicionar el selector en modalidad T.

Dispositivo compatible con todas las prótesis acústicas con modalidad de funcionamiento T (Norma ETS 300381 y EN 60118).

DESCRIPCIÓN DE LOS BORNES



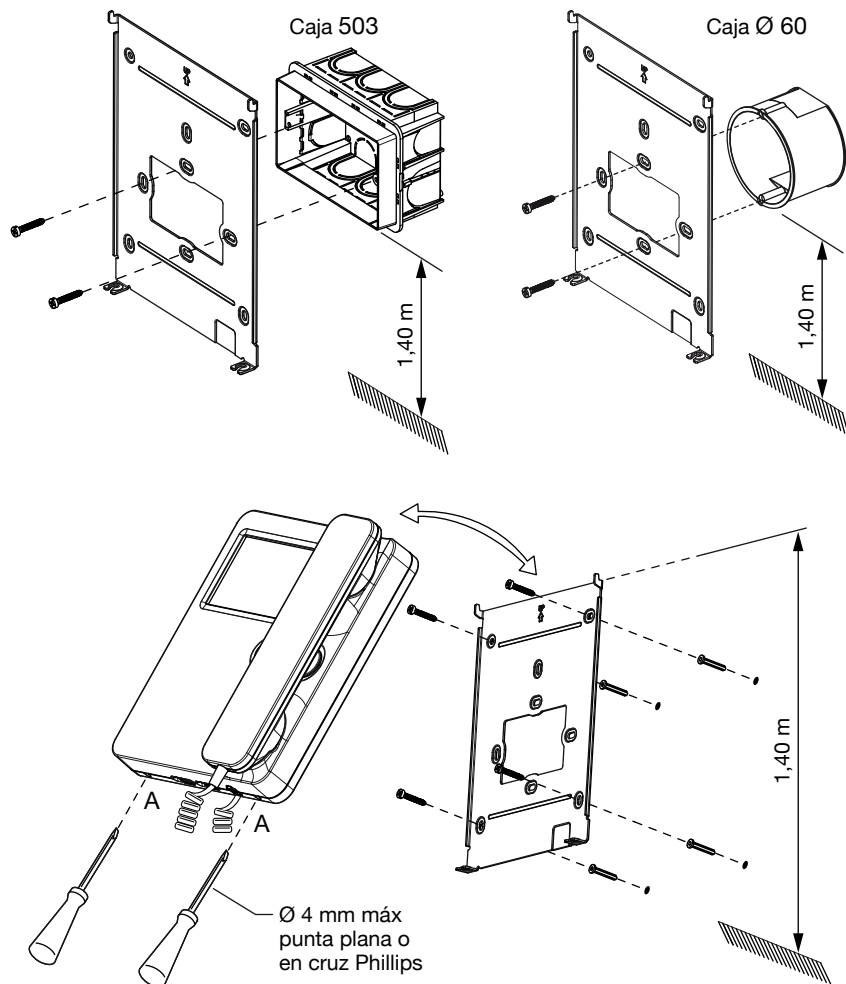

⊘] LINE IN	Conexión al BUS de sistema
⊘		
⊘] CP	Llamada al piso
⊘		
⊘	} S+	} Repetición de llamada
⊘		

INSTALACIÓN

- Fijar el soporte de pared utilizando una caja 503 y los tornillos entregados con el equipo, o una caja \varnothing 60 con tornillos apropiados.
- Programar los interruptores dip de programación.
- Conectar al tablero de bornes los conductores que llegan del sistema.
- Enganchar el monitor en el soporte y bloquearlo enroscando los tornillos de fijación A.



FUNCIÓN DE LOS PULSADORES

ESTADO PULSADOR	EN REPOSO Y COLGADO	ESPERA DE RESPUESTA (RECEPCIÓN LLAMADA)	EN FONÍA	EN REPOSO Y DESCOLGADO	ESTADO DE PROGRAMACIÓN* (SÓLO CON VIDEOINTERFONO EN REPOSO Y COLGADO)
	Apertura de la puerta para peatones	Apertura de la puerta para peatones	Apertura de la puerta para peatones	Apertura de la puerta para peatones	Activa/desactiva la apertura automática de la puerta
	Recorrer memoria vídeo	Función especial (predeterminado: 7)	Función especial (predeterminado: 7)	Llamada intercomunicante 3 programable (predeterminado: no programado)	Regulación volumen de llamada interfónica y al piso (el volumen cambia según la secuencia ALTO, BAJO, SILENCIO)
	Autoactivación	'Rebote vídeo'	Función especial (predeterminado: 8)	Llamada intercomunicante 2 programable (predeterminado: no programado)	Selección del timbre de llamada al piso (5 timbres distintos)
	Apertura de la puerta del pasaje de vehículos	Apertura de la puerta del pasaje de vehículos	Apertura de la puerta del pasaje de vehículos	Llamada intercomunicante 1 programable (predeterminado: llamada a la centralita)	Selección del timbre de llamada al piso (5 timbres distintos)

(*) Para entrar o salir del estado de programación, pulsar y mantener pulsada la tecla ● durante más de 5 segundos; la confirmación de la entrada en programación se produce con el parpadeo lento del led amarillo; en todos los casos, cuando se cumple la temporización de 10 min. se sale del estado de programación.

INDICACIONES DE LOS LED

2. Led verde encendido.
Indica la recepción de una llamada.
6. Led bicolor.

PRIORIDAD	FUNCIONES
1	Rojo parpadeante rápido: silencio activado
2	Verde parpadeante: apertura automática de la puerta activada
3	Rojo encendido fijo: puerta abierta en el puesto de llamada principal
4	Rojo parpadeante lento: puerta abierta en el puesto de llamada secundario
5	Amarillo parpadeante lento: estado de programación activado

 Para guardar la programación, recordarse de salir de la misma manteniendo pulsada la tecla ● durante más de 5 segundos. En todos los casos, después de 10 minutos el dispositivo sale del estado de programación y se guardan los parámetros modificados. Para la programación de la llamada intercomunicante, consultar el manual de sistema.

RESET

Para restablecer los parámetros predeterminados del dispositivo, después de entrar en programación pulsando la tecla ● durante más de 5 segundos, pulsar simultáneamente las teclas ● y  durante más de 3 segundos; la confirmación del mando se produce con la emisión de 2 bips prolongados y la salida del dispositivo del estado de programación.

DEUTSCH

Die Videoanlage Typ 1750/1 ist speziell für die Verwendung in Videoanlagen des Systems 2Voice bestimmt.

GERÄTEBESCHREIBUNG UND GERÄTEDATEN

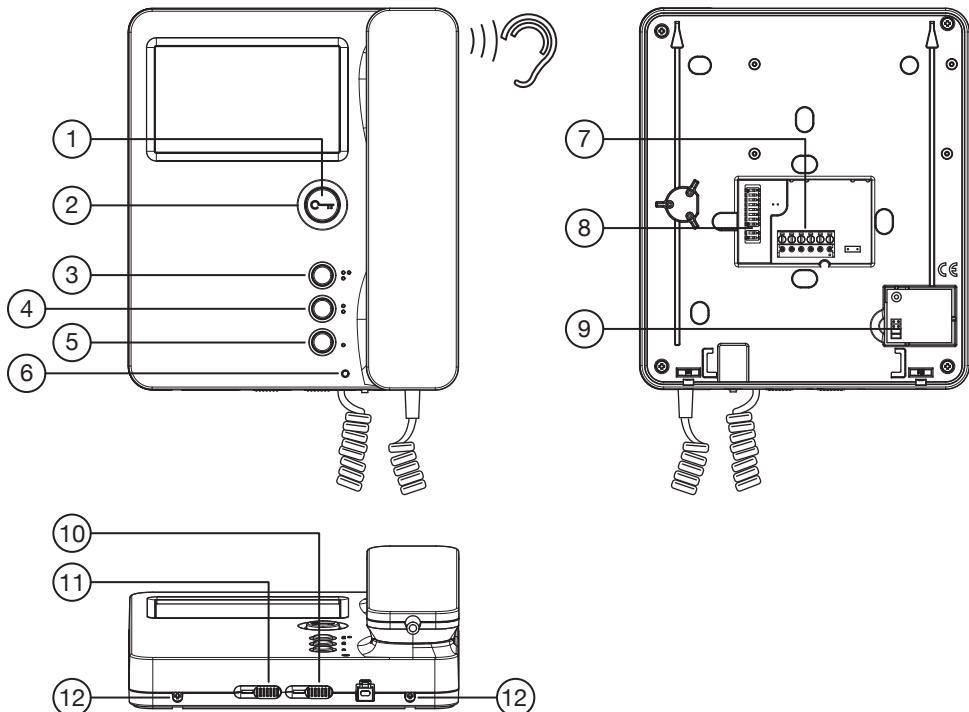

1. Türöffnertaste
2. Grüne Led unter der Türöffnertaste
3. Taste
4. Taste
5. Taste
6. Zweifarbige Led
7. Klemmen für den Systemanschluss
8. Konfigurationsschalter:
 - a. 2 zum Festlegen der Nummer der Innenstelle im Inneren der Wohnung
 - b. 8 zum Festlegen der Nummer der Wohnung in der Steigleitung
9. Vorbereitung für die Ein-Ausgabe-Verbindung mit Zubehör Typ 1750/50
10. Helligkeit
11. Farbe
12. Befestigungsschrauben der Videoanlage an der Halterung

Hinsichtlich der Einstellungen des Kodierschalters siehe Systemhandbuch.

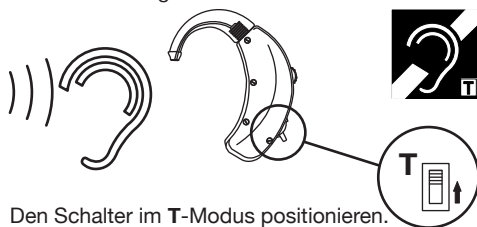
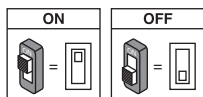

Vorrichtung kompatibel mit allen Hörgeräten mit T Betriebsmodus (Normen ETS 300381 und EN 60118).

ANSCHLUSSKLEMMEN

⊖] LINE IN	Anschluss an den System-BUS
⊖		
⊖] CP	Etageruf
⊖		
⊖	} S+	Rufwiederholung
⊖		

INSTALLATION

- Anbauhalterung mit einer Einbaudose 503 und den beiliegenden Schrauben oder einer Runddose $\varnothing 60$ und entsprechenden Schrauben an der Wand befestigen.
- Die Programmschalter programmieren.
- Die von der Anlage kommenden Leiter an die Klemmenleiste anschließen.
- Den Monitor an der Halterung anbringen und durch Verschrauben der Befestigungsschrauben A fixieren.

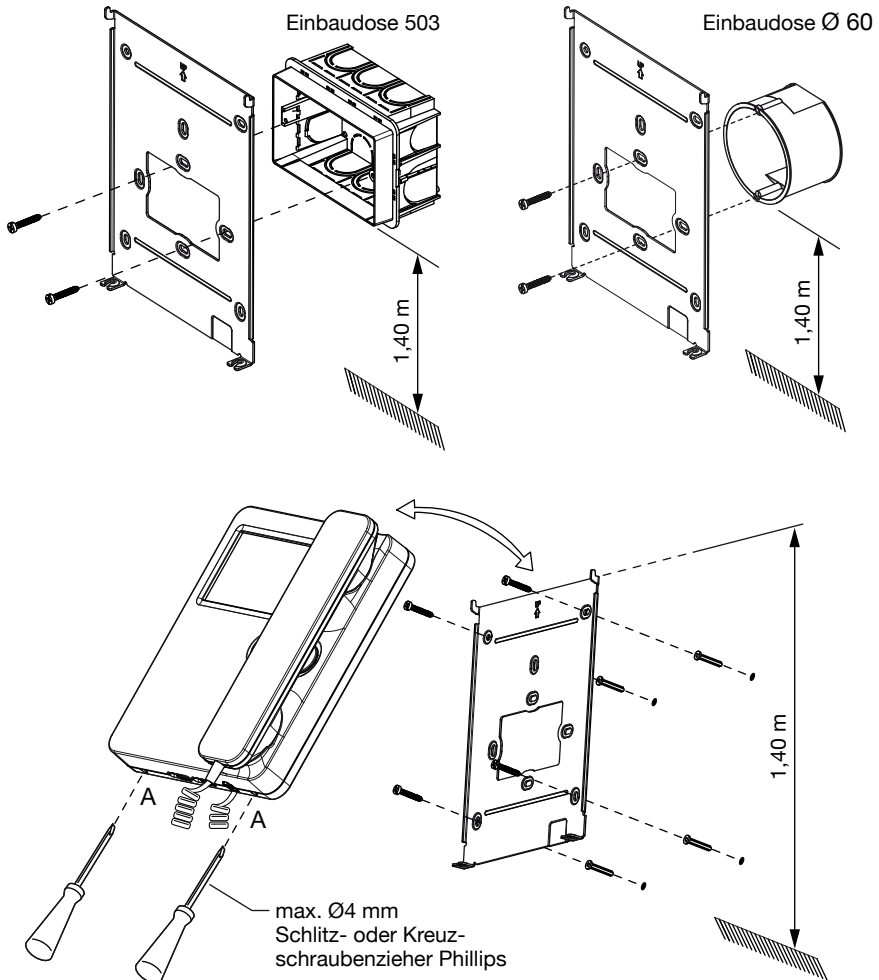

TASTENFUNKTION

STATUS TASTE	RUHESTELLUNG UND EINGEHÄNGT	WARTEZEIT ABHEBEN (RUFINGANG)	IM GESPRÄCH	RUHESTELLUNG UND ABGEHOBBEN	PROGRAMMIERSTATUS* (NUR BEI VIDEOANLAGE IN RUHESTELLUNG MIT AUFGELEGTEM HÖRER)
	Türöffnerbefehl	Türöffnerbefehl	Türöffnerbefehl	Türöffnerbefehl	Automatischen Türöffner ein-/ausschalten
	Durchlauf Videospeicher	Sonderfunktion (Standard: 7)	Sonderfunktion (Standard: 7)	Programmierbarer Intercom-Anruf 3 (Standard: nicht programmiert)	Einstellung der Ruflautstärke der Sprechanlage und auf der Etage (die Lautstärke wechselt in Folge von HOCH, NIEDRIG, MUTE)
	Selbsteinschaltung	Videobildübertragung	Sonderfunktion (Standard: 8)	Programmierbarer Intercom-Anruf 2 (Standard: nicht programmiert)	Auswahl Läutwerk Etagenruf (5 verschiedene Läutwerke)
	Türöffner der Einfahrt	Türöffner der Einfahrt	Türöffner der Einfahrt	Programmierbarer Intercom-Anruf 1 (Standard: Ruf an die Zentrale)	Auswahl Läutwerk Sprechanlagenruf (5 verschiedene Läutwerke)

(*) Um sich in den Programmierstatus zu begeben oder diesen zu verlassen, die Taste ● länger als 5 Sekunden gedrückt halten. Die Bestätigung des Beginns des Programmierstatus erfolgt durch langsames Blinken der gelben Led. In jedem Fall verlässt man nach Ablauf des Takts von 10 Minuten den Programmierstatus.

LED-ANZEIGEN

2. Grüne Led eingeschaltet:
Signalisiert den Empfang eines Anrufs.

6. Zweifarbige Led.

PRIORITÄT	FUNKTIONEN
1	Rot schnell blinkend: Mute aktiv
2	Grün blinkend: automatischer Türöffner aktiv
3	Rot durchgehend eingeschaltet: Tür auf Hauptrufstelle geöffnet
4	Rot blinkend eingeschaltet: Tür auf Nebenrufstelle geöffnet
5	Gelb langsam blinkend: Programmierstatus aktiv

 Um die Programmierung zu speichern, daran denken, diese zu verlassen, indem die Taste ● länger als 5 Sekunden betätigt wird. In jedem Fall verlässt das Gerät nach Ablauf von 10 Minuten den Programmierstatus und speichert die geänderten Parameter.
Zur Programmierung des Intercom-Rufs siehe Systemhandbuch.

RESET

Um die werkseitigen Parameter des Geräts nach dem Zugriff auf die Programmierung durch Betätigen der Taste ● wieder herzustellen, gleichzeitig die Tasten ● und  länger als 3 Sekunden betätigen. Die Bestätigung des Befehls erfolgt durch Aussenden von 2 langen Pfeiftönen und das Verlassen des Programmierstatus von Seiten des Geräts.

DS 1750-003A

URMET S.p.A.
10154 TORINO (ITALY)
VIA BOLOGNA 188/C
Telef. +39 011.24.00.000 (RIC. AUT.)
Fax +39 011.24.00.300 - 323

urmet

LBT 8963

Area tecnica
servizio clienti +39 011.23.39.810
<http://www.urmet.com>
e-mail: info@urmet.com

Fabbricato da Urmet Electronics Limited
(azienda del gruppo Urmet) - Made in P.R.C.
Manufactured by Urmet Electronics Limited
(an Urmet group company) - Made in P.R.C.