

# CP series CP1L CPU Unit

## CP1L-EM□□D□-D/CP1L-EL□□D□-D

## CP1L-M□□DR-A/CP1L-L□□DR-A

### High Performing Programmable Controller with Embedded Ethernet

- "CP1L-EM" and "CP1L-EL" has a standard-feature Ethernet port.
- "CP1L-M" and "CP1L-L" has a standard-feature peripheral USB port.
- Function blocks (FB) allow you to build up modular structure and programming of ladder diagrams.



CP1L-EL CPU Units  
with 20 Points



CP1L-EM CPU Units  
with 40 Points



CP1L-L CPU Units  
with 10 Points



CP1L-M CPU Units  
with 60 Points

### Features

- "CP1L-EM" and "CP1L-EL" have complete with a Ethernet port.
- Pulse output for two axes. Advanced power for high-precision positioning control.
- High-speed Counters. Single-phase for four axes.
- Six interrupt inputs are built in. Faster processing of instructions speeds up the entire system.
- Serial Communications. Two ports. Select Option Boards for either RS-232C or RS-485 communications.
- "CP1L-M" and "CP1L-L" have a peripheral USB port.
- The Structured Text (ST) Language. Makes math operations even easier.
- Can be used for the CP1W series Unit. The extendibility of it is preeminently good.
- LCD displays and settings. Enabled using Option Board.

# CP1L

## Model Number Structure

■ Model Number Legend(Not all models that can be represented with the model number legend can necessarily be produced.)

**CP1L-**□□□**D**□-□  
 (1) (2) (3) (4) (5)

- |   |  |   |
|---|--|---|
| <p>1. Expansion capability<br/>                 E : Ethernet port<br/>                 None : -</p> <p>2. Program capacity<br/>                 M : 10K steps<br/>                 L : 5K steps</p> | <p>3. Number of Built-In number I/O points<br/>                 60 : 60 I/O points<br/>                 40 : 40 I/O points<br/>                 30 : 30 I/O points<br/>                 20 : 20 I/O points<br/>                 14 : 14 I/O points<br/>                 10 : 10 I/O points</p> | <p>4. Output classification<br/>                 R : Relay outputs<br/>                 T : Transistor Outputs (sinking)<br/>                 T1 : Transistor Outputs (sourcing)</p> <p>5. Power supply<br/>                 A : AC<br/>                 D : DC</p> |
|---|--|---|

## Ordering Information

### ● International Standards

- The standards are abbreviated as follows: U: UL, U1: UL (Class I Division 2 Products for Hazardous Locations), C: CSA, UC: cULus, UC1: cULus (Class I Division 2 Products for Hazardous Locations), CU: cUL, N: NK, L: Lloyd, and CE: EC Directives.
- Contact your OMRON representative for further details and applicable conditions for these standards.

### ■ CPU Units

#### Built-in Ethernet port

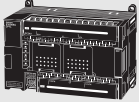
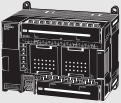
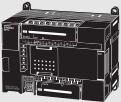

CPU Unit	Specifications					Model	Standards
	CPU type	Power supply	Output method	Inputs	Outputs		
CP1L-EM CPU Units with 40 Points 	Memory capacity: 10K steps High-speed counters: 100 kHz, 4 axes Pulse outputs: 100 kHz, 2 axes (Models with transistor outputs only)	DC power supply	Relay output	24	16	CP1L-EM40DR-D	CE
			Transistor output (sinking)				
			Transistor output (sourcing)				
CP1L-EM CPU Units with 30 Points 	Memory capacity: 10K steps High-speed counters: 100 kHz, 4 axes Pulse outputs: 100 kHz, 2 axes (Models with transistor outputs only)	DC power supply	Relay output	18	12	CP1L-EM30DR-D	CE
			Transistor output (sinking)				
			Transistor output (sourcing)				
CP1L-EL CPU Units with 20 Points 	Memory capacity: 5K steps High-speed counters: 100 kHz, 4 axes Pulse outputs: 100 kHz, 2 axes (Models with transistor outputs only)	DC power supply	Relay output	12	8	CP1L-EL20DR-D	CE
			Transistor output (sinking)				
			Transistor output (sourcing)				

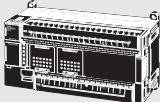
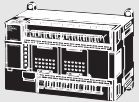
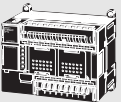
#### Built-in USB port

CPU Unit	Specifications					Model	Standards
	CPU type	Power supply	Output method	Inputs	Outputs		
CP1L-M CPU Units with 60 Points 	Memory capacity: 10K steps High-speed counters: 100 kHz, 4 axes Pulse outputs: 100 kHz, 2 axes (Models with transistor outputs only)	AC power supply	Relay output	36	24	CP1L-M60DR-A	UC1, N, L, CE
			Transistor output (sinking)				
		DC power supply	Relay output				
			Transistor output (sinking)				
CP1L-M CPU Units with 40 Points 	Memory capacity: 10K steps High-speed counters: 100 kHz, 4 axes Pulse outputs: 100 kHz, 2 axes (Models with transistor outputs only)	AC power supply	Relay output	24	16	CP1L-M40DR-A	UC1, N, L, CE
			Transistor output (sinking)				
		DC power supply	Relay output				
			Transistor output (sinking)				
CP1L-M CPU Units with 30 Points 	Memory capacity: 10K steps High-speed counters: 100 kHz, 4 axes Pulse outputs: 100 kHz, 2 axes (Models with transistor outputs only)	AC power supply	Relay output	18	12	CP1L-M30DR-A	UC1, N, L, CE
			Transistor output (sinking)				
		DC power supply	Relay output				
			Transistor output (sinking)				









Windows are either registered trademarks or trademarks of Microsoft Corporation in the United States and/or other countries.

Other company names and product names in this document are the trademarks or registered trademarks of their respective companies.

CPU Unit	Specifications					Model	Standards
	CPU type	Power supply	Output method	Inputs	Outputs		
<b>CP1L-L CPU Units with 20 Points</b> 	<b>Memory capacity: 5K steps</b> <b>High-speed counters: 100 kHz, 4 axes</b> <b>Pulse outputs: 100 kHz, 2 axes</b> <b>(Models with transistor outputs only)</b>	AC power supply	Relay output	12	8	CP1L-L20DR-A	UC1, N, L, CE
			Transistor output (sinking)			CP1L-L20DT-A	
		DC power supply	Relay output	6	4	CP1L-L20DR-D	
			Transistor output (sinking)			CP1L-L20DT-D	
			Transistor output (sourcing)			CP1L-L20DT1-D	
<b>CP1L-L CPU Units with 14 Points</b> 	<b>Memory capacity: 5K steps</b> <b>High-speed counters: 100 kHz, 4 axes</b> <b>Pulse outputs: 100 kHz, 2 axes</b> <b>(Models with transistor outputs only)</b>	AC power supply	Relay output	8	6	CP1L-L14DR-A	UC1, N, L, CE
			Transistor output (sinking)			CP1L-L14DT-A	
		DC power supply	Relay output	6	4	CP1L-L14DR-D	
			Transistor output (sinking)			CP1L-L14DT-D	
			Transistor output (sourcing)			CP1L-L14DT1-D	
<b>CP1L-L CPU Units with 10 Point</b> 	<b>Memory capacity: 5K steps</b> <b>High-speed counters: 100 kHz, 4 axes</b> <b>Pulse outputs: 100 kHz, 2 axes</b> <b>(Models with transistor outputs only)</b>	AC power supply	Relay output	6	4	CP1L-L10DR-A	UC1, N, L, CE
			Transistor output (sinking)			CP1L-L10DT-A	
		DC power supply	Relay output	4	2	CP1L-L10DR-D	
			Transistor output (sinking)			CP1L-L10DT-D	
			Transistor output (sourcing)			CP1L-L10DT1-D	

**Note:** 1. Refer to "Models and Software Versions" about supported software.  
 2. Refer to "Option Unit Specifications" about supported Option Units.

■ Options for CPU Units

Name	Specifications	Model	Standards
<b>RS-232C Option Board</b> 	Can be mounted in either CPU Unit Option Board slot 1 or 2. *1	CP1W-CIF01	UC1, N, L, CE
<b>RS-422A/485 Option Board</b> 		CP1W-CIF11	
<b>RS-422A/485 (Isolated-type) Option Board</b> 		CP1W-CIF12	
<b>Ethernet Option Board</b> 	Can be mounted in either CPU Unit Option Board slot 1 or 2. *1 *2 *4	CP1W-CIF41	
<b>Analog Input Option Board</b> 	Can be mounted in either CPU Unit Option Board slot 1 or 2. *3 2 analog inputs. 0-10V(Resolution:1/4000), 0-20mA (Resolution:1/2000).	CP1W-ADB21	
<b>Analog Output Option Board</b> 	Can be mounted in either CPU Unit Option Board slot 1 or 2. *3 2 analog outputs. 0-10V (Resolution:1/4000).	CP1W-DAB21V	
<b>Analog I/O Option Board</b> 	Can be mounted in either CPU Unit Option Board slot 1 or 2. *3 2 analog inputs. 0-10V(Resolution:1/4000), 0-20mA(Resolution:1/2000). 2 analog outputs. 0-10V (Resolution:1/4000).	CP1W-MAB221	
<b>LCD Option Board</b> 	Can be mounted only in the CPU Unit Option Board slot 1. *1	CP1W-DAM01	
<b>Memory Cassette</b> 	Can be used for backing up programs or auto-booting.	CP1W-ME05M	

\*1. Cannot be used for the CP1L-L10.

\*2. When using CP1W-CIF41 Ver.1.0, one Ethernet port can be added.

\*3. CP1L-EM / EL only.

\*4. Cannot be used for the CP1L-EM / EL.

## ■ Programming Devices

Name	Specifications		Model	Standards	
		Number of licenses			Media
<b>FA Integrated Tool Package CX-One Lite Version 4.□</b>	CX-One Lite is a subset of the complete CX-One package that provides only the Support Software required for micro PLC applications. CX-One Lite runs on the following OS. OS: Windows XP (Service Pack 3 or higher, 32-bit version) / Windows Vista (32-bit/64-bit version) / Windows 7 (32-bit/64-bit version) / Windows 8 (32-bit/64-bit version) / Windows 8.1 (32-bit/64-bit version)  CX-One Lite Ver. 4.□ includes Micro PLC Edition CX-Programmer Ver. 9.□.	1 license	CD	<b>CXONE-LT01C-V4</b>	---
<b>FA Integrated Tool Package CX-One Ver. 4.□</b>	CX-One is a package that integrates the Support Software for OMRON PLCs and components. CX-One runs on the following OS. OS: Windows XP (Service Pack 3 or higher, 32-bit version) / Windows Vista (32-bit/64-bit version) / Windows 7 (32-bit/64-bit version) / Windows 8 (32-bit/64-bit version) / Windows 8.1 (32-bit/64-bit version)  CX-One Ver. 4.□ includes CX-Programmer Ver. 9.□.	1 license *1	DVD *2	<b>CXONE-AL01D-V4</b>	---
<b>Programming Device Connecting Cable for CP1W-CIF01 RS-232C Option Board *3</b>	Connects Personal Computers, D-Sub 9-pin (Length: 2.0 m)	For anti-static connectors		<b>XW2Z-200S-CV</b>	---
	Connects Personal Computers, D-Sub 9-pin (Length: 5.0 m)			<b>XW2Z-500S-CV</b>	
	Connects Personal Computers, D-Sub 9-pin (Length: 2.0 m)			<b>XW2Z-200S-V</b>	
	Connects Personal Computers, D-Sub 9-pin (Length: 5.0 m)			<b>XW2Z-500S-V</b>	
<b>USB-Serial Conversion Cable *3</b>	USB-RS-232C Conversion Cable (Length: 0.5 m) and PC driver (on a CD-ROM disc) are included. Complies with USB Specification 2.0 On personal computer side: USB (A plug connector, male) On PLC side: RS-232C (D-sub 9-pin, male) Driver: Supported by Windows 98, Me, 2000, XP(32bit), Vista(32bit/64bit), 7(32bit/64bit) and 8(32bit/64bit)			<b>CS1W-CIF31</b>	N

**Note:** 1. Refer to "Models and Software Versions" about supported software.

2. The CX-One and CX-One Lite cannot be simultaneously installed on the same computer.

\*1. Multi licenses are available for the CX-One (3, 10, 30 or 50 licenses).

\*2. The CX-One is also available on CD (CXONE-AL□□C-V4).

\*3. Cannot be used with a peripheral USB port.

To connect to a personal computer via a peripheral USB port, use commercially-available USB cable (A or B type, male).

The following tables lists the Support Software that can be installed from CX-One

Support Software in CX-One	CX-One Lite Ver.4.□	CX-One Ver.4.□	Support Software in CX-One	CX-One Lite Ver.4.□	CX-One Ver.4.□
Micro PLC Edition CX-Programmer Ver.9.□	Yes	No	CX-Drive Ver.2.□	Yes	Yes
CX-Programmer Ver.9.□	No	Yes	CX-Process Tool Ver.5.□	No	Yes
CX-Integrator Ver.2.□	Yes	Yes	Faceplate Auto-Builder for NS Ver.3.□	No	Yes
Switch Box Utility Ver.1.□	Yes	Yes	CX-Designer Ver.3.□	Yes	Yes
CX-Protocol Ver.1.□	No	Yes	NV-Designer Ver.1.□	Yes	Yes
CX-Simulator Ver.1.□	Yes	Yes	CX-Thermo Ver.4.□	Yes	Yes
CX-Position Ver.2.□	No	Yes	CX-ConfiguratorFDT Ver.1.□	Yes	Yes
CX-Motion-NCF Ver.1.□	No	Yes	CX-FLnet Ver.1.□	No	Yes
CX-Motion-MCH Ver.2.□	No	Yes	Network Configurator Ver.3.□	Yes	Yes
CX-Motion Ver.2.□	No	Yes	CX-Server Ver.4.□	Yes	Yes

**Note:** For details, refer to the CX-One Catalog (Cat. No: R134).

## ● Models and Software Versions







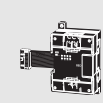
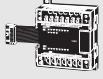

The following versions of the CX-One, CX-Programmer are required.

Model	CX-One	CX-Programmer
CP1L-EM40□□-□ CP1L-EM30□□-□ CP1L-EL20□□-□	*1 Ver. 4.25 or higher	Ver. 9.40 or higher
CP1L-M60□□-□	*2 Ver. 2.11 or higher	Ver. 7.20 or higher
CP1L-M40□□-□ CP1L-M30□□-□ CP1L-M20□□-□ CP1L-L14□□-□	*2 Ver. 2.10 or higher	Ver. 7.10 or higher
CP1L-L10□□-□	*2 Ver. 2.13 or higher	Ver. 7.30 or higher

\*1. Update The CX-Programmer version automatically from the website using CX-Programmer version 9.0 (included with CX-One version 4.0).

\*2. Update The CX-Programmer version automatically from the website using CX-Programmer version 7.0 (included with CX-One version 2.0).

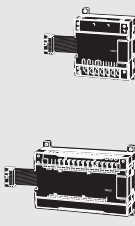
■ Expansion Units

Product name	Inputs	Outputs	Output type	Model	Standards	
<b>Input Unit</b>	8	--	24 VDC Input	CP1W-8ED	U, C, N, L, CE	
<b>Output Units</b> 	--	8	Relay	CP1W-8ER		
			Transistor (sinking)	CP1W-8ET		
			Transistor (sourcing)	CP1W-8ET1		
	--	16	Relay	CP1W-16ER		N, L, CE
			Transistor (sinking)	CP1W-16ET		
			Transistor (sourcing)	CP1W-16ET1		
	--	32	Relay	CP1W-32ER		N, L, CE
			Transistor (sinking)	CP1W-32ET		
			Transistor (sourcing)	CP1W-32ET1		
<b>I/O Units</b> 	12	8	Relay	CP1W-20EDR1	U, C, N, L, CE	
			Transistor (sinking)	CP1W-20EDT		
			Transistor (sourcing)	CP1W-20EDT1		
	24	16	Relay	CP1W-40EDR	N, L, CE	
Transistor (sinking)			CP1W-40EDT			
Transistor (sourcing)			CP1W-40EDT1			
<b>Analog Input Unit</b> 	4CH	--	Input range: 0 to 5 V, 1 to 5 V, 0 to 10 V, ±10 V, 0 to 20 mA, or 4 to 20 mA.	Resolution: 1/6000	CP1W-AD041	UC1, N, L, CE
				Resolution: 1/12000	CP1W-AD042	UC1, CE
<b>Analog Output Unit</b> 	--	2CH	Output range: 1 to 5 V, 0 to 10 V, ±10 V, 0 to 20 mA, or 4 to 20 mA.	Resolution: 1/6000	CP1W-DA021	UC1, N, L, CE
	--	4CH		Resolution: 1/6000	CP1W-DA041	
				Resolution: 1/12000	CP1W-DA042	UC1, CE
<b>Analog I/O Unit</b> 	4CH	4CH	Input range: 0 to 5 V, 1 to 5 V, 0 to 10 V, ±10 V, 0 to 20 mA, or 4 to 20 mA. Output range: 1 to 5 V, 0 to 10 V, ±10 V, 0 to 20 mA, or 4 to 20 mA.	Resolution: 1/12000	CP1W-MAD44	UC1, CE
	4CH	2CH		Resolution: 1/12000	CP1W-MAD42	
	2CH	1CH		Resolution: 1/6000	CP1W-MAD11	UC1, N, L, CE
<b>Temperature Sensor Unit</b> 	2CH	--	Sensor type: Thermocouple (J or K)		CP1W-TS001	UC1, N, L, CE
	4CH	--	Sensor type: Thermocouple (J or K)		CP1W-TS002	
	2CH	--	Sensor type: Platinum resistance thermometer (Pt100 or JPt100)		CP1W-TS101	
	4CH	--	Sensor type: Platinum resistance thermometer (Pt100 or JPt100)		CP1W-TS102	
	4CH	--	Sensor type: Thermocouple (J or K) 2 channels can be used as analog input. Input range: 1 to 5 V, 0 to 10 V, 4-20 mA	Resolution: 1/12000	CP1W-TS003	
	12CH	--	Sensor type: Thermocouple (J or K)		CP1W-TS004	
<b>CompoBus/S I/O Link Unit</b> 	8	8	CompoBus/S slave		CP1W-SRT21	UC1, N, L, CE

Note: CP1L (L Type) CPU Units with 10 points do not support Expansion Units.

# CP1L

## ■ I/O Connecting Cable



Name	Specifications	Model	Standards
I/O Connecting Cable	80 cm (for CP1W Expansion Units)	CP1W-CN811	UC1, N, L, CE

Note: An I/O Connecting Cable (approx. 6 cm) for horizontal connection is provided with CP1W Expansion Units.

## ■ Optional Products, Maintenance Products and DIN Track Accessories

Name	Specifications	Model	Standards
Battery Set	For CPU Units (Use batteries within two years of manufacture.)	CJ1W-BAT01	CE
DIN Track	Length: 0.5 m; Height: 7.3 mm	PFP-50N	---
	Length: 1 m; Height: 7.3 mm	PFP-100N	
	Length: 1 m; Height: 16 mm	PFP-100N2	
End Plate	A stopper to secure the Units on the DIN Track.	PFP-M	

## ■ Industrial Switching Hubs

Product name	Appearance	Specifications			Accessories	Current consumption (A)	Model	Standards
		Functions	No. of ports	Failure detection				
Industrial Switching Hubs		Quality of Service (QoS): EtherNet/IP control data priority Failure detection: Broadcast storm and LSI error detection 10/100BASE-TX, Auto-Negotiation	3	No	• Power supply connector	0.22	W4S1-03B	UC, CE
	5		No	0.22		W4S1-05B		
			5	Yes	• Power supply connector • Connector for informing error	0.22	W4S1-05C	CE

## General Specifications

Item	Type Model	AC power supply models	DC power supply models
		CP1L-□□□-A	CP1L-□□□-D
Power supply		100 to 240 VAC 50/60 Hz	24 VDC
Operating voltage range		85 to 264 VAC	20.4 to 26.4 VDC
Power consumption		50 VA max. (CP1L-M60/-M40/-M30□□-A) 30 VA max. (CP1L-L20/-L14/-L10□□-A)	20 W max. (CP1L-EM40/-EM30/-M60/-M40/-M30□□-D) 13 W max. (CP1L-EL20/-L20/-L14/-L10□□-D)
Inrush current *		100 to 120 VAC inputs: 20 A max. (for cold start at room temperature) 8 ms max. 200 to 240 VAC inputs: 40 A max. (for cold start at room temperature), 8 ms max.	30 A max. (for cold start at room temperature) 20 ms max.
External power supply		300 mA at 24 VDC (CP1L-M60/-M40/-M30□□-A) 200 mA at 24 VDC (CP1L-L20/-L14/-L10□□-A)	None
Insulation resistance		20 MΩ min. (at 500 VDC) between the external AC terminals and GR terminals	No insulation between primary and secondary for DC power supply
Dielectric strength		2,300 VAC at 50/60 Hz for 1 min between the external AC and GR terminals, leakage current: 5 mA max.	No insulation between primary and secondary for DC power supply
Noise immunity		Conforms to IEC 61000-4-4. 2 kV (power supply line)	
Vibration resistance		CP1L-L/M: Conforms to JIS C60068-2-6. 10 to 57 Hz, 0.075-mm amplitude, 57 to 150 Hz, acceleration: 9.8 m/s <sup>2</sup> in X, Y, and Z directions for 80 minutes each. Sweep time: 8 minutes × 10 sweeps = total time of 80 minutes) CP1L-EL/EM: 5 to 8.4 Hz, 3.5 mm amplitude, 8.4 to 150 Hz, acceleration: 9.8 m/s <sup>2</sup> in X, Y, and Z directions for 100 minutes each (time coefficient of 10 minutes × coefficient factor of 10 = total time of 100 minutes)	
Shock resistance		Conforms to JIS C60068-2-27. 147 m/s <sup>2</sup> three times each in X, Y, and Z directions	
Ambient operating temperature		0 to 55°C	
Ambient humidity		10% to 90% (with no condensation)	
Ambient operating environment		No corrosive gas	
Ambient storage temperature		-20 to 75°C (Excluding battery.)	
Power holding time		10 ms min.	2 ms min.

\* The above values are for a cold start at room temperature for an AC power supply, and for a cold start for a DC power supply.

- A thermistor (with low-temperature current suppression characteristics) is used in the inrush current control circuitry for the AC power supply. The thermistor will not be sufficiently cooled if the ambient temperature is high or if a hot start is performed when the power supply has been OFF for only a short time. In those cases the inrush current values may be higher (as much as two times higher) than those shown above. Always allow for this when selecting fuses and breakers for external circuits.
- A capacitor charge-type delay circuit is used in the inrush current control circuitry for the DC power supply. The capacitor will not be charged if a hot start is performed when the power supply has been OFF for only a short time, so in those cases the inrush current values may be higher (as much as two times higher) than those shown above.

## Performance Specifications

### ● CP1L CPU Unit (EM/EL Type)

Item	Type Models	CP1L-EM40 (40 points)	CP1L-EM30 (30 points)	CP1L-EL20 (20 points)
		CP1L-EM40□□□□	CP1L-EM30□□□□	CP1L-EL20□□□□
Control method		Stored program method		
I/O control method		Cyclic scan with immediate refreshing		
Program language		Ladder diagram		
Function blocks		Maximum number of function block definitions: 128 Maximum number of instances: 256 Languages usable in function block definitions: Ladder diagrams, structured text (ST)		
Instruction length		1 to 7 steps per instruction		
Instructions		Approx. 500 (function codes: 3 digits)		
Instruction execution time		Basic instructions: 0.55 μs min. Special instructions: 4.1 μs min.		
Common processing time		0.4ms		
Program capacity		10K steps	5K steps	
	FB program memory	10K steps		
Number of tasks		288 (32 cyclic tasks and 256 interrupt tasks)		
	Scheduled interrupt tasks	1 (interrupt task No. 2, fixed)		
	Input interrupt tasks	6 (interrupt task No. 140 to 145, fixed) (High-speed counter interrupts and interrupt tasks specified by external interrupts can also be executed.)		
Maximum subroutine number		256		
Maximum jump number		256		
I/O areas	Input Area	1,600 bits (100 words) CIO 0 to CIO 99		
	Built-in Input Area	24 bits: CIO 0.00 to CIO 0.11 and CIO 1.00 to CIO 1.11	18 bits: CIO 0.00 to CIO 0.11 and CIO 1.00 to CIO 1.05	12 bits: CIO 0.00 to CIO 0.11
	Output Area	1,600 bits (100 words) CIO 100 to CIO 199		
	Built-in Output Area	16 bits: CIO 100.00 to CIO 100.07 and CIO 101.00 to CIO 101.07	12 bits: CIO 100.00 to CIO 100.07 and CIO 101.00 to CIO 101.03	8 bits: CIO 100.00 to CIO 100.07
	1:1 Link Area	256 bits (16 words): CIO 3000.00 to CIO 3015.15 (CIO 3000 to CIO 3015)		
Serial PLC Link Area	1,440 bits (90 words): CIO 3100.00 to CIO 3189.15 (CIO 3100 to CIO 3189)			
Work bits		4,800 bits (300 words): CIO 1200.00 to CIO 1499.15 (words CIO 1200 to CIO 1499) 6,400 bits (400 words): CIO 1500.00 to CIO 1899.15 (words CIO 1500 to CIO 1899) 15,360 bits (960 words): CIO 2000.00 to CIO 2959.15 (words CIO 2000 to CIO 2959) 9,600 bits (600 words): CIO 3200.00 to CIO 3799.15 (words CIO 3200 to CIO 3799) 37,504 bits (2,344 words): CIO 3800.00 to CIO 6143.15 (words CIO 3800 to CIO 6143)		
TR Area		16 bits: TR0 to TR15		
Holding Area		8,192 bits (512 words): H0.00 to H511.15 (H0 to H511)		
AR Area		Read-only (Write-prohibited): 7168 bits (448 words): A0.00 to A447.15 (A0 to A447) Read/Write: 8192 bits (512 words): A448.00 to A959.15 (A448 to A959)		
Timers		4,096 timer numbers: T0 to T4095		
Counters		4,096 counter numbers: C0 to C4095		
DM Area		32 Kwords: D0 to D32767	10 Kwords: D0 to D9999, D32000 to D32767	
Data Register Area		16 registers (16 bits): DR0 to DR15		
Index Register Area		16 registers (32 bits): IR0 to IR15		
Task Flag Area		32 flags (32 bits): TK0000 to TK0031		
Trace Memory		4,000 words (500 samples for the trace data maximum of 31 bits and 6 words.)		
Memory Cassette		A special Memory Cassette (CP1W-ME05M) can be mounted. <b>Note:</b> Can be used for program backups and auto-booting.		
Clock function		Supported. Accuracy (monthly deviation): -4.5 min to -0.5 min (ambient temperature: 55°C), -2.0 min to +2.0 min (ambient temperature: 25°C), -2.5 min to +1.5 min (ambient temperature: 0°C)		
Communications functions		Built-in Ethernet Port (Connecting Support Software, Message Communications, Socket Service)		
		A maximum of two Serial Communications Option Boards can be mounted.	A maximum of one Serial Communications Option Board can be mounted.	
Memory backup		Flash memory: User programs, parameters (such as the PLC Setup), comment data, and the entire DM Area can be saved to flash memory as initial values. Battery backup: The Holding Area, DM Area, and counter values (flags, PV) are backed up by a battery.		
Battery service life		Service life expectancy is 5 years at 25°C, less at higher temperatures. (From 0.75 to 5 years depending on model, power supply rate, and ambient temperature.)		
Built-in input terminals		40 (24 inputs, 16 outputs)	30 (18 inputs, 12 outputs)	20 (12 inputs, 8 outputs)
Number of connectable Expansion Units and Expansion I/O Units		CP-series Expansion Unit and Expansion I/O Units: 3 max.		CP-series Expansion Units and Expansion I/O Units: 1 max.
Max. number of I/O points		160 (40 built in + 40 per Expansion I/O Unit x 3 Units)	150 (30 built in + 40 per Expansion I/O Unit x 3 Units)	60 (20 built in + 40 per Expansion I/O Unit x 1 Unit)
Interrupt inputs		6 inputs (Response time: 0.3 ms)		
Interrupt inputs counter mode		6 inputs (Response frequency: 5 kHz max. for all interrupt inputs), 16 bits Up or down counters		
Quick-response inputs		6 points (Min. input pulse width: 50 μs max.)		
Scheduled interrupts		1		
High-speed counters		4 inputs/2 axes (24 VDC) Differential phases (4x), 50 kHz Single-phase (pulse plus direction, up/down, increment), 100 kHz Value range: 32 bits, Linear mode or ring mode Interrupts: Target value comparison or range comparison		

# CP1L

		Type	CP1L-EM40 (40 points)	CP1L-EM30 (30 points)	CP1L-EL20 (20 points)
		Models	CP1L-EM40□□-□	CP1L-EM30□□-□	CP1L-EL20□□-□
Pulse outputs (models with transistor outputs only)	Pulse outputs	Trapezoidal or S-curve acceleration and deceleration (Duty ratio: 50% fixed) 2 outputs, 1 Hz to 100 kHz (CCW/CW or pulse plus direction)			
	PWM outputs	Duty ratio: 0.0% to 100.0% (specified in increments of 0.1% or 1%) 2 outputs, 0.1 to 6553.5 Hz or 1 to 32,800 Hz (Accuracy: +1%/0% at 0.1 Hz to 10,000 Hz and +5%/0% at 10,000 Hz to 32,800 Hz)			
Analog input		2 input (Resolution: 1/1000, Input range: 0 to 10 V). Not isolated.			

## ● CP1L CPU Unit (M/L Type)

		Type	CP1L-M60 (60 points)	CP1L-M40 (40 points)	CP1L-M30 (30 points)	CP1L-L20 (20 points)	CP1L-L14 (14 points)	CP1L-L10 (10 points)	
		Models	CP1L-M60□□-□	CP1L-M40□□-□	CP1L-M30□□-□	CP1L-L20□□-□	CP1L-L14□□-□	CP1L-L10□□-□	
Control method		Stored program method							
I/O control method		Cyclic scan with immediate refreshing							
Program language		Ladder diagram							
Function blocks		Maximum number of function block definitions: 128 Maximum number of instances: 256 Languages usable in function block definitions: Ladder diagrams, structured text (ST)							
Instruction length		1 to 7 steps per instruction							
Instructions		Approx. 500 (function codes: 3 digits)							
Instruction execution time		Basic instructions: 0.55 μs min. Special instructions: 4.1 μs min.							
Common processing time		0.4 ms							
Program capacity		10K steps					5K steps		
Number of tasks		288 (32 cyclic tasks and 256 interrupt tasks)							
		Scheduled interrupt tasks		1 (interrupt task No. 2, fixed)					
		Input interrupt tasks		6 (interrupt task No. 140 to 145, fixed)			4 (interrupt task No. 140 to 143, fixed)	2 (interrupt task No. 140 to 141, fixed)	
		(Interrupt tasks can also be specified and executed for high-speed counter interrupts and executed.)							
Maximum subroutine number		256							
Maximum jump number		256							
I/O areas		Input Area		1,600 bits (100 words) CIO 0 to CIO 99					
		Built-in Input Area		36 bits: CIO 0.00 to CIO 0.11 and CIO 1.00 to CIO 1.11 and CIO 2.00 to CIO 2.11	24 bits: CIO 0.00 to CIO 0.11 and CIO 1.00 to CIO 1.11	18 bits: CIO 0.00 to CIO 0.11 and CIO 1.00 to CIO 1.05	12 bits: CIO 0.00 to CIO 0.11	8 bits: CIO 0.00 to CIO 0.07	6 bits: CIO 0.00 to CIO 0.05
		Output Area		1,600 bits (100 words) CIO 100 to CIO 199					
		Built-in Output Area		24 bits: CIO 100.00 to CIO 100.07 and CIO 101.00 to CIO 101.07 and CIO 102.00 to CIO 102.07	16 bits: CIO 100.00 to CIO 100.07 and CIO 101.00 to CIO 101.07	12 bits: CIO 100.00 to CIO 100.07 and CIO 101.00 to CIO 100.03	8 bits: CIO 100.00 to CIO 100.07	6 bits: CIO 100.00 to CIO 100.05	4 bits: CIO 100.00 to CIO 100.03
		1:1 Link Area		256 bits (16 words): CIO 3000.00 to CIO 3015.15 (CIO 3000 to CIO 3015)					
		Serial PLC Link Area		1,440 bits (90 words): CIO 3100.00 to CIO 3189.15 (CIO 3100 to CIO 3189)					
Work bits		8,192 bits (512 words): W000.00 to W511.15 (W0 to W511) CIO Area: 37,504 bits (2,344 words): CIO 3800.00 to CIO 6143.15 (CIO 3800 to CIO 6143)							
TR Area		16 bits: TR0 to TR15							
Holding Area		8,192 bits (512 words): H0.00 to H511.15 (H0 to H511)							
AR Area		Read-only (Write-prohibited): 7168 bits (448 words): A0.00 to A447.15 (A0 to A447) Read/Write: 8192 bits (512 words): A448.00 to A959.15 (A448 to A959)							
Timers		4,096 timer numbers: T0 to T4095							
Counters		4,096 counter numbers: C0 to C4095							
DM Area		32 Kwords: D0 to D32767				10 Kwords: D0 to D9999, D32000 to D32767			
Data Register Area		16 registers (16 bits): DR0 to DR15							
Index Register Area		16 registers (32 bits): IR0 to IR15							
Task Flag Area		32 flags (32 bits): TK0000 to TK0031							
Trace Memory		4,000 words (500 samples for the trace data maximum of 31 bits and 6 words.)							
Memory Cassette		A special Memory Cassette (CP1W-ME05M) can be mounted. <b>Note:</b> Can be used for program backups and auto-booting.							
Clock function		Supported. Accuracy (monthly deviation): -4.5 min to -0.5 min (ambient temperature: 55°C), -2.0 min to +2.0 min (ambient temperature: 25°C), -2.5 min to +1.5 min (ambient temperature: 0°C)							
Communications functions		One built-in peripheral port (USB 1.1): For connecting Support Software only.					A maximum of two Serial Communications Option Boards can be mounted.	A maximum of one Serial Communications Option Board can be mounted.	Not supported.
		A maximum of two Ethernet Option Board can be mounted. When using CP1W-CIF41 Ver.1.0, one Ethernet Option Board can be mounted.					A maximum of one Ethernet Option Board can be mounted.	A maximum of one Ethernet Option Board can be mounted.	Not supported.
Memory backup		Flash memory: User programs, parameters (such as the PLC Setup), comment data, and the entire DM Area can be saved to flash memory as initial values. Battery backup: The Holding Area, DM Area, and counter values (flags, PV) are backed up by a battery.							
Battery service life		Service life expectancy is 5 years at 25°C, less at higher temperatures. (From 0.75 to 5 years depending on model, power supply rate, and ambient temperature.)							



Type		CP1L-M60 (60 points)	CP1L-M40 (40 points)	CP1L-M30 (30 points)	CP1L-L20 (20 points)	CP1L-L14 (14 points)	CP1L-L10 (10 points)
Item	Models	CP1L-M60□□-□	CP1L-M40□□-□	CP1L-M30□□-□	CP1L-L20□□-□	CP1L-L14□□-□	CP1L-L10□□-□
<b>Built-in input terminals</b>		60 (36 inputs, 24 outputs)	40 (24 inputs, 16 outputs)	30 (18 inputs, 12 outputs)	20 (12 inputs, 8 outputs)	14 (8 inputs, 6 outputs)	10 (6 inputs, 4 outputs)
<b>Number of connectable Expansion Units and Expansion I/O Units</b>		CP-series Expansion Unit and Expansion I/O Units: 3 max.			CP-series Expansion Units and Expansion I/O Units: 1 max.		Not supported.
<b>Max. number of I/O points</b>		180 (60 built in + 40 per Expansion (I/O) Unit × 3 Units)	160 (40 built in + 40 per Expansion (I/O) Unit × 3 Units)	150 (30 built in + 40 per Expansion (I/O) Unit × 3 Units)	60 (20 built in + 40 per Expansion (I/O) Unit × 1 Unit)	54 (14 built in + 40 per Expansion (I/O) Unit × 1 Unit)	10 (10 built in)
<b>Interrupt inputs</b>		6 inputs (Response time: 0.3 ms)				4 inputs (Response time: 0.3 ms)	2 inputs (Response time: 0.3 ms)
<b>Interrupt inputs counter mode</b>		6 inputs (Response frequency: 5 kHz max. for all interrupt inputs), 16 bits Up or down counters				4 inputs (Response frequency: 5 kHz max. for all interrupt inputs), 16 bits Up or down counters	2 inputs (Response frequency: 5 kHz max. for all interrupt inputs), 16 bits Up or down counters
<b>Quick-response inputs</b>		6 points (Min. input pulse width: 50 μs max.)				4 points (Min. input pulse width: 50 μs max.)	2 points (Min. input pulse width: 50 μs max.)
<b>Scheduled interrupts</b>		1					
<b>High-speed counters</b>		4 inputs/2 axes (24 VDC): Differential phases (4x), 50 kHz Single-phase (pulse plus direction, up/down, increment), 100 kHz Value range: 32 bits, Linear mode or ring mode Interrupts: Target value comparison or range comparison					
<b>Pulse outputs (models with transistor outputs only)</b>	<b>Pulse outputs</b>	Trapezoidal or S-curve acceleration and deceleration (Duty ratio: 50% fixed) 2 outputs, 1 Hz to 100 kHz (CCW/CW or pulse plus direction)					
	<b>PWM outputs</b>	Duty ratio: 0.0% to 100.0% (specified in increments of 0.1% or 1%) 2 outputs, 0.1 to 6553.5 Hz or 1 to 32,800 Hz (Accuracy: +1%/0% at 0.1 Hz to 10,000 Hz and +5%/0% at 10,000 Hz to 32,800 Hz)					
<b>Analog control</b>		1 (Setting range: 0 to 255)					
<b>Analog input</b>		1 input (Resolution: 1/256, Input range: 0 to 10 V). Not isolated.					

# CP1L

## Built-in Inputs

### Input Terminal Block Arrangement (Top Block)

#### ● CP1L (60 Inputs)

- AC Power Supply Models

L1	L2/N	COM	01	03	05	07	09	11	01	03	05	07	09	11	01	03	05	07	09	11
			00	02	04	06	08	10	00	02	04	06	08	10	00	02	04	06	08	10
Inputs (CIO 0)						Inputs (CIO 1)						Inputs (CIO 2)								

- DC Power Supply Models

+	-	COM	01	03	05	07	09	11	01	03	05	07	09	11	01	03	05	07	09	11
NC			00	02	04	06	08	10	00	02	04	06	08	10	00	02	04	06	08	10
Inputs (CIO 0)						Inputs (CIO 1)						Inputs (CIO 2)								

#### ● CP1L (40 Inputs)

- AC Power Supply Models

L1	L2/N	COM	01	03	05	07	09	11	01	03	05	07	09	11
			00	02	04	06	08	10	00	02	04	06	08	10
Inputs (CIO 0)							Inputs (CIO 1)							

- DC Power Supply Models

+	-	COM	01	03	05	07	09	11	01	03	05	07	09	11
NC			00	02	04	06	08	10	00	02	04	06	08	10
Inputs (CIO 0)							Inputs (CIO 1)							

#### ● CP1L (30 inputs)

- AC Power Supply Models

L1	L2/N	COM	01	03	05	07	09	11	01	03	05	
			00	02	04	06	08	10	00	02	04	NC
Inputs (CIO 0)						Inputs (CIO 1)						

- DC Power Supply Models

+	-	COM	01	03	05	07	09	11	01	03	05	
NC			00	02	04	06	08	10	00	02	04	NC
Inputs (CIO 0)						Inputs (CIO 1)						

#### ● CP1L (20 Inputs)

- AC Power Supply Models

L1	L2/N	COM	01	03	05	07	09	11
			00	02	04	06	08	10
Inputs (CIO 0)								

- DC Power Supply Models

+	-	COM	01	03	05	07	09	11
NC			00	02	04	06	08	10
Inputs (CIO 0)								

#### ● CP1L (14 Inputs)

- AC Power Supply Models

L1	L2/N	COM	01	03	05	07	NC	NC
			00	02	04	06	NC	NC
Inputs (CIO 0)								

- DC Power Supply Models

+	-	COM	01	03	05	07	NC	NC
NC			00	02	04	06	NC	NC
Inputs (CIO 0)								

#### ● CP1L (10 Inputs)

- AC Power Supply Models

L1	L2/N	COM	01	03	05
			00	02	04
Inputs (CIO 0)					

- DC Power Supply Models

{		COM	01	03	05
NC			00	02	04
Inputs (CIO 0)					

■ Built-in Input Area

Number of inputs	Input terminal block		Input operation			High-speed counter operation		Origin search		
	Word	Bit	Normal inputs	Interrupt inputs	Quick-response inputs	Operation settings • High-speed counters enabled • Phase-Z signal reset		Origin searches enabled for pulse outputs 0 and 1		
						Single-phase (increment pulse input)	Two-phase (differential phase x4, up/down, or pulse plus direction)	CPU Units with 20 to 60 points	CPU Units with 14 points	CPU Units with 10 points
10	CIO 0	00	Normal input 0	---	---	High-speed counter 0 (increment)	High-speed counter 0 (phase-A, increment, or count input)	---	---	---
		01	Normal input 1	---	---	High-speed counter 1 (increment)	High-speed counter 0 (phase-B, decrement, or direction)	---	---	---
		02	Normal input 2	---	---	High-speed counter 2 (increment)	High-speed counter 1 (phase-A, increment, or count input)	---	Pulse output 0: Origin proximity input signal	---
		03	Normal input 3	---	---	High-speed counter 3 (increment)	High-speed counter 1 (phase-B, decrement, or count input)	---	Pulse output 1: Origin proximity input signal	Pulse output 0: Origin proximity input signal
		04	Normal input 4	Interrupt input 0	Quick-response input 0	Counter 0, phase-Z/reset input	High-speed counter 0 (phase-Z/reset)	---	---	---
		05	Normal input 5	Interrupt input 1	Quick-response input 1	Counter 1, phase-Z/reset input	High-speed counter 1 (phase-Z/reset)	---	---	Pulse output 0: Origin input signal-
		06	Normal input 6	Interrupt input 2	Quick-response input 2	Counter 2, phase-Z/reset input		Pulse output 0: Origin input signal		---
		07	Normal input 7	Interrupt input 3	Quick-response input 3	Counter 3, phase-Z/reset input		Pulse output 1: Origin input signal		---
		08	Normal input 8	Interrupt input 4	Quick-response input 4	---		---	---	---
		09	Normal input 9	Interrupt input 5	Quick-response input 5	---		---	---	---
		20		10	Normal input 10	---	---	---		Pulse output 0: Origin proximity input signal
		11	Normal input 11	---	---	---		Pulse output 1: Origin proximity input signal	---	
30	CIO 1	00	Normal input 12	---	---	---	---	---	---	
		to	to	to	to	to	to	to	to	
		05	Normal input 17	---	---	---	---	---	---	
40		06	Normal input 18	---	---	---	---	---	---	
		to	to	to	to	to	to	to	to	
		11	Normal input 23	---	---	---	---	---	---	
60	CIO 2	00	Normal input 24	---	---	---	---	---	---	
		to	to	to	to	to	to	to	to	
		11	Normal input 35	---	---	---	---	---	---	

# CP1L

## Built-in Outputs

### ■ Output Terminal Block Arrangement (Bottom Block)

#### ● CP1L (60 Outputs)

- AC Power Supply Models

+	00	01	02	04	05	07	00	02	04	05	07	00	02	04	05	07
-	COM	COM	COM	03	COM	06	COM	01	03	COM	06	COM	01	03	COM	06
CIO 100			CIO 101			CIO 102										

- DC Power Supply Models

NC	00	01	02	04	05	07	00	02	04	05	07	00	02	04	05	07
NC	COM	COM	COM	03	COM	06	COM	01	03	COM	06	COM	01	03	COM	06
CIO 100			CIO 101			CIO 102										

#### ● CP1L (40 Outputs)

- AC Power Supply Models

+	00	01	02	03	04	06	00	01	03	04	05
-	COM	COM	COM	COM	05	07	COM	02	COM	05	07
CIO 100			CIO 101								

- DC Power Supply Models

CP1L-EM40DR-D/CP1L-M40D□-D

NC	00	01	02	03	04	06	00	01	03	04	06
NC	COM	COM	COM	COM	05	07	COM	02	COM	05	07
CIO 100			CIO 101								

CP1L-EM40DT-D

V+	00	01	02	03	04	06	00	01	03	04	06
V-	COM(V-)		COM	05	07	COM	02	COM	05	07	
CIO 100			CIO 101								

CP1L-EM40DT1-D

V+	00	01	02	03	04	06	00	01	03	04	06
V-	COM(V+)		COM	05	07	COM	02	COM	05	07	
CIO 100			CIO 101								

#### ● CP1L (30 Outputs)

- AC Power Supply Models

+	00	01	02	04	05	07	00	02	
-	COM	COM	COM	03	COM	06	COM	01	03
CIO 100			CIO 101						

- DC Power Supply Models

CP1L-EM30DR-D/CP1L-M30D□-D

NC	00	01	02	04	05	07	00	02	
NC	COM	COM	COM	03	COM	06	COM	01	03
CIO 100			CIO 101						

CP1L-EM30DT-D

V+	00	01	02	04	05	07	00	02
V-	COM(V-)		03	COM	06	COM	01	03
CIO 100			CIO 101					

CP1L-EM30DT1-D

V+	00	01	02	04	05	07	00	02
V-	COM(V+)		03	COM	06	COM	01	03
CIO 100			CIO 101					

#### ● CP1L (20 Outputs)

- AC Power Supply Models

+	00	01	02	04	05	07
-	COM	COM	COM	03	COM	06
CIO 100						

- DC Power Supply Models

CP1L-EL20DR-D/CP1L-L20D□-D

NC	00	01	02	04	05	07
NC	COM	COM	COM	03	COM	06
CIO 100						

CP1L-EL20DT-D

V+	00	01	02	04	05	07
V-	COM(V-)		03	COM	06	
CIO 100						

CP1L-EL20DT1-D

V+	00	01	02	04	05	07
V-	COM(V+)		03	COM	06	
CIO 100						

#### ● CP1L (14 Outputs)

- AC Power Supply Models

+	00	01	02	04	05	NC
-	COM	COM	COM	03	COM	NC
CIO 100						

- DC Power Supply Models

NC	00	01	02	04	05	NC
NC	COM	COM	COM	03	COM	NC
CIO 100						

#### ● CP1L (10 Outputs)

- AC Power Supply Models

f	00	01	02
l	COM	COM	03
CIO 100			

- DC Power Supply Models

NC	00	01	02
NC	COM	COM	03
CIO 100			

■ Built-in Output Area

Number of outputs	Output Terminal Block		When the instructions to the right are not executed	When a pulse output instruction (SPED, ACC, PLS2, or ORG) is executed	When the origin search function is set to be used in the PLC Setup, and an origin search is executed by the ORG instruction	When the PWM instruction is executed		
	Word	Bit	Normal output	Fixed duty ratio pulse output				Variable duty ratio pulse output
				CW/CCW	Pulse plus direction	When the origin search function is used		PWM output
CPU Units with 14 to 60 points	CPU Units with 10 point							
10	CIO 100	00	Normal output 0	Pulse output 0 (CW)	Pulse output 0 (pulse)	---	---	---
		01	Normal output 1	Pulse output 0 (CCW)	Pulse output 0 (direction)	---	---	PWM output 0
		02	Normal output 2	Pulse output 1 (CW)	Pulse output 1 (pulse)	---	---	---
		03	Normal output 3	Pulse output 1 (CCW)	Pulse output 1 (direction)	---	Origin search 0 (Error counter reset output)	PWM output 1
		04	Normal output 4	---	---	Origin search 0 (Error counter reset output)	---	---
		05	Normal output 5	---	---	Origin search 1 (Error counter reset output)	---	---
		06	Normal output 6	---	---	---	---	---
14	CIO 100	07	Normal output 7	---	---	---	---	---
		08	Normal output 8	---	---	---	---	---
20	CIO 100	to	to	to	to	to	to	to
		03	Normal output 11	---	---	---	---	---
		04	Normal output 12	---	---	---	---	---
30	CIO 101	to	to	to	to	to	to	to
		07	Normal output 15	---	---	---	---	---
40	CIO 101	to	to	to	to	to	to	to
		01	Normal output 16	---	---	---	---	---
		to	to	to	to	to	to	to
60	CIO 102	07	Normal output 23	---	---	---	---	---
		to	to	to	to	to	to	to

# CP1L

## I/O Specifications for CPU Units

### Input Specifications

ITEM	Specifications		
	High-speed counter inputs (phases A and B) *1	Interrupt inputs and quick-response inputs *1	Normal inputs
	CIO 0.00 to CIO 0.03	CIO 0.04 to CIO 0.09 *2	CIO 0.10 to CIO 0.11, CIO 1.00 to CIO 1.11, and CIO 2.00 to 2.11 *2
Input voltage	24 VDC +10%/–15%		
Applicable sensors	2-wire sensors or 3-wire sensors		
Input impedance	3.0 kΩ		4.7 kΩ
Input current	7.5 mA typical		5 mA typical
ON voltage	17.0 VDC min.		14.4 VDC min.
OFF voltage/current	1 mA max. at 5.0 VDC		
ON delay *3	2.5 μs max.	50 μs max.	1 ms max.
OFF delay *3	2.5 μs max.	50 μs max.	1 ms max.
Circuit configuration			

\*1. High-speed counter inputs, interrupt inputs, and quick-response inputs can also be used as normal inputs.

\*2. The bits that can be used depend on the model of CPU Unit.

\*3. The response time is the hardware delay value. The delay set in the PLC Setup (0 to 32 ms, default: 8 ms) must be added to this value.

### High-speed Counter Function Input Specifications

Input bits: CIO 0.00 to CIO 0.03

Item	Specifications
ON/OFF delay	<ul style="list-style-type: none"> <li>Pulse plus direction input mode</li> <li>Increment mode</li> <li>Up/down input mode</li> </ul>

### Interrupt Input Counter Mode

Input bits: CIO 0.04 to CIO 0.09

Item	Specifications
ON/OFF delay	

### Output Specifications

#### CPU Units with Relay Outputs

Item	Specifications	
Max. switching capacity	2 A, 250 VAC ( $\cos\phi = 1$ ), 2 A, 24 VDC 4 A/common	
Min. switching capacity	5 VDC, 10 mA	
Service life of relay	Resistive load	100,000 operations (24 VDC)
	Inductive load	48,000 operations (250 VAC, $\cos\phi = 0.4$ )
	Mechanical	20,000,000 operations
ON delay	15 ms max.	
OFF delay	15 ms max.	
Circuit configuration		

**Note:** There are restrictions in the power supply voltage and output load current imposed by the ambient temperature for CPU Units with DC power. Refer to the CP1L CPU Unit Operation Manual (Cat. No. W462) or the CP Series CP1L-EL/EM CPU Unit Operation Manual (Cat. No. W516).

● CPU Units with Transistor Outputs (Sinking/Sourcing)

Item	Specifications		
	CIO 100.00 to CIO 100.03 *1	CIO 100.04 to CIO 100.07 *2	
Max. switching capacity	4.5 to 30 VDC, 300 mA/output, 0.9 A/common, EM40D□-D 3.6 A/Unit EM30D□-D 2.7 A/Unit EL20D□-D 1.8 A/Unit M60D□-D 5.4 A/Unit M40D□-D 3.6 A/Unit M30D□-D 2.7 A/Unit L20D□-D 1.8 A/Unit L14D□-D 1.5 A/Unit L10D□-D 0.9 A/Unit		
Min. switching capacity	4.5 to 30 VDC, 1 mA		
Leakage current	0.1 mA max.		
Residual voltage	0.6 V max.	1.5 V max.	
ON delay	0.1 ms max.		
OFF delay	0.1 ms max.		
Fuse	CP1L-L/M CPU Unit: 1/common *3 CP1L-EL/EM CPU Unit: None		
Circuit configuration	CP1L-EL/EM CPU Unit	Sinking Outputs 	Sinking Outputs 
		Sourcing Outputs 	Sourcing Outputs 
	CP1L-L/M CPU Unit	Sinking Outputs 	Sinking Outputs 
		Sourcing Outputs 	Sourcing Outputs 

Note: Do not apply a voltage or connect a load to an output terminal exceeding the maximum switching capacity.

\*1. Also do not exceed 0.9 A for the total of CIO 100.00 to CIO 100.03, which are different common.

\*2. The bits that can be used depend on the model of the CPU Unit.

\*3. The fuse cannot be replaced by the user.

● Pulse outputs

Output bits CIO 100.00 to CIO 100.03

Item	Specifications
Max. switching capacity	30 mA at 4.75 to 26.4 VDC
Min. switching capacity	7 mA at 4.75 to 26.4 VDC
Max. output frequency	100 kHz
Output waveform	

- Note:
- The above values assume a resistive load and do not consider the impedance of the cable connecting the load.
  - The pulse widths during actual use may be smaller than the ones shown above due to pulse distortion caused by connecting cable impedance.
  - The OFF and ON refer to the output transistor. The output transistor is ON at level "L".

● PWM outputs

Output bits CIO100.01, CIO 100.03

Item	Specifications
Max. switching capacity	30 mA at 4.75 to 26.4 VDC
Max. output frequency	32.8 kHz
PWM output precision	For ON duty +1%, "0%": 10 kHz output For ON duty +5%, "0%": 0 to 32.8 kHz output
Output waveform	

Note: The OFF and ON refer to the output transistor. The output transistor is ON at level "L".

## External Analog Setting Input Specifications

Item	Specifications
Number of analog inputs	1
Input signal range	0 to 10V
Resolution	1/256 (full scale)
Isolation method	None

Note: CP1L-L CPU Unit or CP1L-M CPU Unit only.

## Analog Input Specifications

Item	Specifications
Number of inputs	2 inputs (2 words allocated in the AR Area)
Input signal range	Voltage input: 0 V to 10 V
Max. rated input	0 V to 15 V
External input impedance	100 K $\Omega$ min.
Resolution	1/1000 (full scale)
Overall accuracy	25°C: $\pm 2.0\%$ (full scale) 0 to 55°C: $\pm 3.0\%$ (full scale)
A/D conversion data	0000 to 03E8 hex
Averaging function	Not supported
Conversion time	Same as PLC cycle time
Isolation method	None

Note: CP1L-EL CPU Unit or CP1L-EM CPU Unit only.

## Built-in Ethernet Specifications (CP1H-EL CPU Units or CP1H-EM CPU Unit Only)

Item	Specifications
Protocol used	TCP/IP, UDP, ARP, ICMP (ping only), BOOTP
Applications	FINS, Socket, SNTP, DNS (client)
Media access method	CSMA/CD
Modulation method	Baseband
Transmission paths	Star form
Baud rate	100 Mbit/s (100Base-TX), 10 Mbit/s (10Base-T)
Transmission media	100 Mbit/s <ul style="list-style-type: none"> <li>Unshielded twisted-pair (UDP) cable Categories: 5, 5e</li> <li>Shielded twisted-pair (STP) cable Categories: 100 <math>\Omega</math> at 5, 5e</li> </ul>
	10 Mbit/s <ul style="list-style-type: none"> <li>Unshielded twisted-pair (UDP) cable Categories: 3, 4, 5, 5e</li> <li>Shielded twisted-pair (STP) cable Categories: 100 <math>\Omega</math> at 3, 4, 5, 5e</li> </ul>
Transmission Distance	100 m (distance between hub and node)

Item	FINS Communications Service Specifications	
Number of nodes	254	
Message length	1016 bytes max.	
Size of buffer	8k	
Communications Function	FINS Communications Service (UDP/IP, TCP/IP)	
FINS/UDP method	Protocol used	UDP/IP
	Port number	9600 (default) Can be changed.
	Protection	No
FINS/TCP method	Protocol used	TCP/IP
	Number of connections	Up to 2 simultaneous connections and only one connection can be set to client
	Port number	9600 (default) Can be changed.
	Protection	Yes (Specification of client IP addresses when unit is used as a server)

\*1. CX-One version 4.3 or higher is required.

\*2. To connect the CP1L CPUs with the NS-series Programmable Terminals via Ethernet, make sure that the system version of NS Series is 8.2 or higher.



## External Interfaces

### ■ CP1L CPU Unit Nomenclature

#### ● CP1L CPU Units (EL Type) with 20 Points

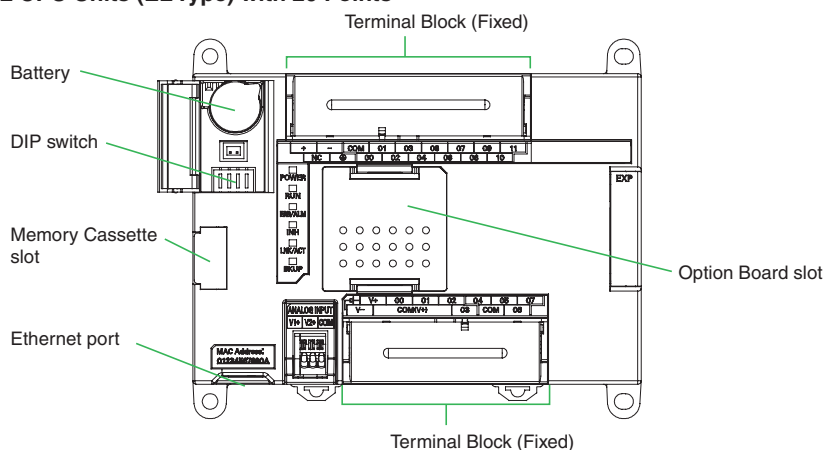

#### ● CP1L CPU Units (EM Type) with 40 or 30 Points

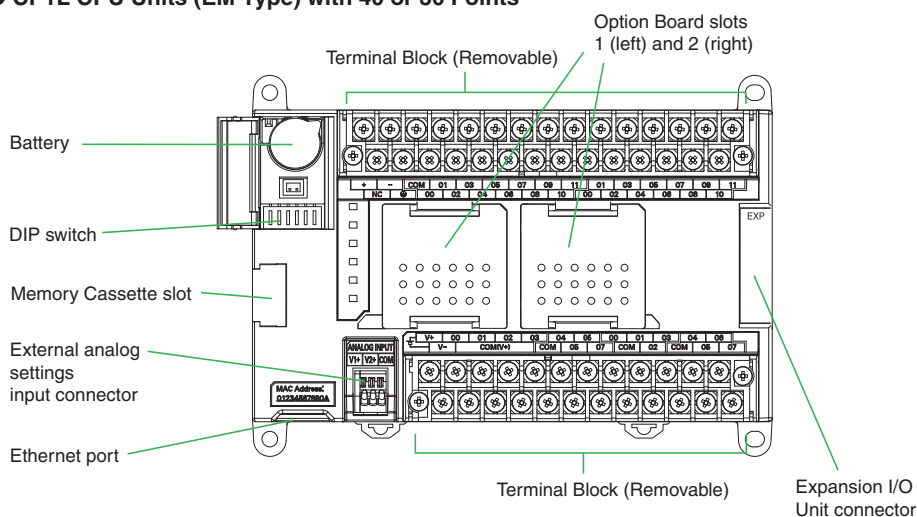

#### ● CP1L CPU Units (MType) with 40 Points

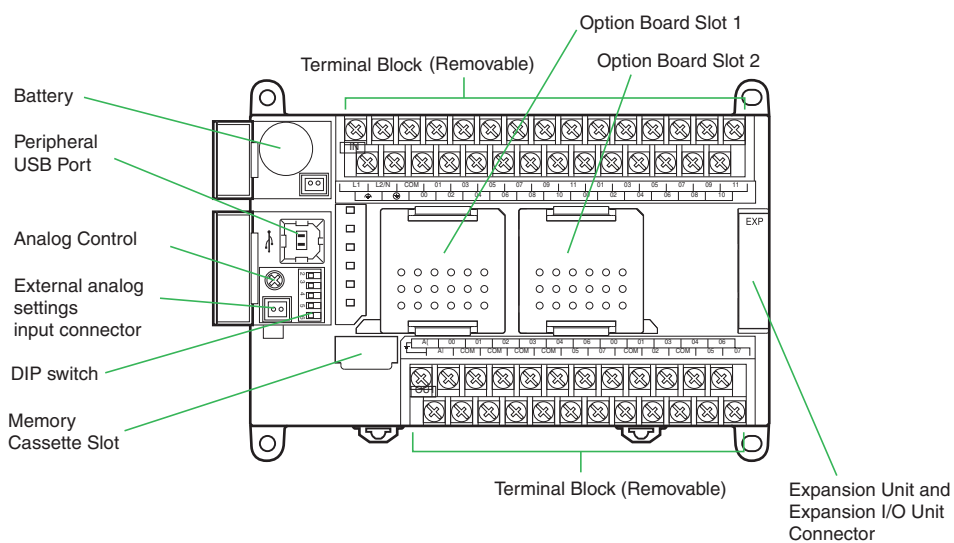

# CP1L

## ● CP1L CPU Units (L Type) with 20 or 14 Points

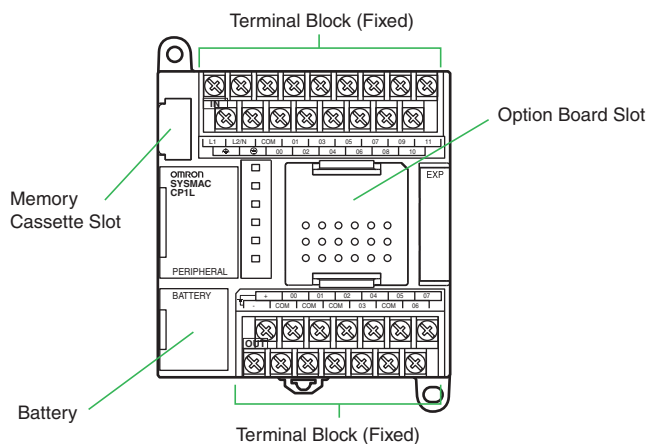

## ● CP1L CPU Units (L Type) with 10 Points

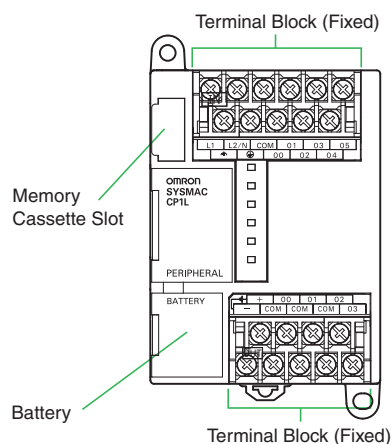

## Connection Methods

### ■ Built-in Standard Features

Yes : Supported, No : Not supported

Item	Interface	Applicable CPU Units				
		CP1L-EM Type	CP1L-EL Type	CP1L-M Type	CP1L-L14/L20	CP1L-L10
Ethernet port	Connecting Support Software, Message Communications, and the other.	Yes	Yes	No	No	No
Peripheral USB port	Bus for communications with various kinds of Support Software running on a personal computer.	No	No	Yes	Yes	Yes

### ■ Option Unit Specifications

Yes : Supported, No : Not supported

Item	Option Boards	Applicable CPU Units				
		CP1L-EM Type	CP1L-EL Type	CP1L-M Type	CP1L-L14/L20	CP1L-L10
Serial port 1 * (Option board slot 1)	Serial Communications Option Boards (CP1W-CIF01/CIF11/CIF12)	Yes	Yes	Yes	Yes	No
	Ethernet Option Boards (CP1W-CIF41)	No	No	Yes	Yes	No
	Analog I/O Option Boards (CP1W-MAB21/ADB21/DAB21V)	Yes	Yes	No	No	No
	LCD Option Boards (CP1W-DAM01)	Yes	Yes	Yes	Yes	No
Serial port 2 * (Option board slot 2)	Serial Communications Option Boards (CP1W-CIF01/CIF11/CIF12)	Yes	No	Yes	No	No
	Ethernet Option Boards (CP1W-CIF41)	No	No	Yes	No	No
	Analog I/O Option Boards (CP1W-MAB21/ADB21/DAB21V)	Yes	No	No	No	No

\* You can choose one from among "Yes".

### ■ Serial Communications Option Boards (CP1W-CIF01/CIF11/CIF12)

Product name	Model	Specifications	Serial communications mode
RS-232C Option Board	CP1W-CIF01	One RS-232C port Connector: D-Sub, 9 pin, female Maximum transmission distance: 15m One RS-232C connector (D-Sub, 9 pin, male) is included.	Host Link, 1:N NT Link, 1:1 NT Link, Noprotocol, Serial PLC Link Slave, Serial PLC Link Master, Serial Gateway converted to CompoWay/F, and Tool Bus, 1:1 Link Master, and 1:1 Link Slave.
RS-422A/485 Option Board	CP1W-CIF11	One RS-422A/485 port Terminal block: using ferrules Maximum transmission distance: 50m	
RS-422A/485 Isolated-type Option Board	CP1W-CIF12	One RS-422A/485 port (Isolated) Terminal block: using ferrules Maximum transmission distance: 500m	

**Note:** 1. Serial PLC Link can be used with either serial port 1 or serial port 2.  
2. Cannot be used for the CP1L-L10.

## ■ Ethernet Communications Specifications (CP1W-CIF41)

Item		Specifications			
Applicable PLCs		CP1L CPU Units <b>Note:</b> The Ethernet Option Board cannot be used for the CP1L-EM/EL/L10.			
Number of Units that can be mounted		2 sets. (The CP1W-CIF41 Ver.1.0 and Ver.2.0 can be combined and used with one CPU Unit. When using CP1W-CIF41 Ver.1.0, only one unit can be mounted in an option board slot.)			
Protocol used		TCP/IP, UDP			
Server/Client		Only server (Cannot be used as a client)			
Applications		FINS			
Transfer	Media access method	CSMA/CD			
	Modulation method	Baseband			
	Transmission paths	Star form			
	Baud rate	100 Mbit/s (100Base-TX), 10 Mbit/s (10Base-T)			
	Transmission media	<table border="0"> <tr> <td style="text-align: center; vertical-align: middle;">100 Mbit/s</td> <td> <ul style="list-style-type: none"> <li>Unshielded twisted-pair (UDP) cable Categories: 5, 5e</li> <li>Shielded twisted-pair (STP) cable Categories: 100 Ω at 5, 5e</li> </ul> </td> </tr> <tr> <td style="text-align: center; vertical-align: middle;">10 Mbit/s</td> <td> <ul style="list-style-type: none"> <li>Unshielded twisted-pair (UDP) cable Categories: 3, 4, 5, 5e</li> <li>Shielded twisted-pair (STP) cable Categories: 100 Ω at 3, 4, 5, 5e</li> </ul> </td> </tr> </table>	100 Mbit/s	<ul style="list-style-type: none"> <li>Unshielded twisted-pair (UDP) cable Categories: 5, 5e</li> <li>Shielded twisted-pair (STP) cable Categories: 100 Ω at 5, 5e</li> </ul>	10 Mbit/s
100 Mbit/s	<ul style="list-style-type: none"> <li>Unshielded twisted-pair (UDP) cable Categories: 5, 5e</li> <li>Shielded twisted-pair (STP) cable Categories: 100 Ω at 5, 5e</li> </ul>				
10 Mbit/s	<ul style="list-style-type: none"> <li>Unshielded twisted-pair (UDP) cable Categories: 3, 4, 5, 5e</li> <li>Shielded twisted-pair (STP) cable Categories: 100 Ω at 3, 4, 5, 5e</li> </ul>				
Transmission Distance		100 m (distance between hub and node)			

Item		FINS Communications Service Specifications
Number of nodes		254
Message length		1016 bytes max.
Size of buffer		8k
Communications Function		FINS Communications Service (UDP/IP, TCP/IP)
FINS/UDP method	Protocol used	UDP/IP
	Port number	9600 (default) Can be changed.
	Protection	No
FINS/TCP method	Protocol used	TCP/IP
	Number of connections	Up to 2 simultaneous connections and only one connection can be set to client
	Port number	9600 (default) Can be changed.
Protection		Yes (Specification of client IP addresses when unit is used as a server)

- Note:**
1. CX-Programmer version 8.1 or higher (CX-One version 3.1 or higher) is required.
  2. Use CX-Integrator version 2.33 or higher (CX-One version 3.1 or higher) when the system needs to be set the routing tables. However, CX-Integrator does not support the other functions, using CP1W-CIF41, such as transferring the parameters and network structure.
  3. To connect the CP1H/CP1L CPUs with the NS-series Programmable Terminals via Ethernet using CP1W-CIF41, make sure that the system version of NS Series is 8.2 or higher.

## ■ Analog I/O Option Board (CP1W-ADB21/DAB21V/MAB221)

Product name	Model	Specifications		
		Input		Output
		Voltage Input 0V to 10V	Current Input 0mA to 20mA	Voltage Output 0V to 10V
		Resolution:1/4000	Resolution:1/2000	Resolution:1/4000
Analog Input Option Board	CP1W-ADB21	2CH		-
Analog Output Option Board	CP1W-DAB21V	-		2CH
Analog I/O Option Board	CP1W-MAB221	2CH		2CH

**Note:** CP1L-EL CPU Unit or CP1L-EM CPU Unit only.

## ■ Analog Option Board Refresh Time

Analog Option Board	Cycle time (ms)		
	1 ms	10 ms	20 ms
CP1W-ADB21	40 ±30%	50 ±30%	80 ±30%
CP1W-DAB21V	30 ±40%	40 ±50%	70 ±40%
CP1W-MAB221(AD)	60 ±40%	80 ±60%	100 ±50%
CP1W-MAB221(DA)	40 ±80%	60 ±60%	90 ±50%

## ■ LCD Option board (CP1W-DAM01)

### ● Specifications

Item	Function
Mounting port	CP1L: Option board slot 1 <b>Note:</b> The LCD Option Board cannot be used for the CP1L-L10.
Communications protocol	Peripheral bus (Turn ON DIP switch pin 4.)
Weight	30 g max.
Number of display characters	4 rows × 12 characters: 48 characters max.
Display characters	5 × 7 dots (alphanumeric and symbols).
Backlight	Electroluminescence (EL): Normal: Lit green; Error: Flashing red

### ● LCD Functions

Operation	Description
Changing operating modes	Change the PLC operating mode without using the CX-Programmer.
I/O memory	Read and change the present values in the memory areas and force-set or force-reset bits.
PLC Setup operations	Read and change the PLC Setup.
Analog I/O monitor	Monitor the analog adjustment and present value for the external analog setting input.
Error log display	Read the log of errors that have occurred.
Memory cassette operation	Transfer and verify user programs between the PLC and memory cassette.
User monitor settings	Read the status of up to 16 words and bits with comments. You can use this setting to read data on the startup display.
Message display function settings	Display a user-set message of up to 48 characters on the LCD Option Board when a specified bit turns ON. A maximum of 16 screens can be registered for display.
Timers	<p><b>Day timer</b></p> <p>Use this timer for ON/OFF switching at a specified times every day from the starting day of the week to the ending day of the week. Sixteen timers can be set from timer 01 to timer 16.</p> <p>Operation:</p>
	<p><b>Weekly timer</b></p> <p>Use this timer for ON/OFF operation in intervals of one week that starts one day and ends another day. Sixteen timers can be set from timer No. 01 to timer No. 16.</p> <p>Operation:</p>
	<p><b>Calendar timer</b></p> <p>Use the calendar timers for ON or OFF operation in intervals of one year from the starting day to the ending day. Sixteen timers can be set from timer 01 to timer 16.</p> <p>Operation:</p>
Saving setting	Save the various settings that you set with the LCD Option Board to the DM Area of the PLC. You can also write the settings saved in the PLC to the LCD Option Board.
Language	Changing the display language (Japanese/English)
Other functions	<ul style="list-style-type: none"> <li>• Setting the time of the PLC's built-in clock</li> <li>• Reading system data (e.g., unit version and lot number)</li> <li>• Setting the backlight lighting time</li> <li>• Adjusting LCD contrast</li> <li>• Reading cycle time (e.g., average, maximum, and minimum)</li> <li>• Clearing data for the LCD Option Board</li> </ul>

# CP1L

## Expansion I/O Unit Specifications

### ■ CP1W-40EDR/40EDT/40EDT1/32ER/32ET/32ET1/20EDR1/20EDT/20EDT1/16ER/16ET/16ET1/8ED/8ER/8ET/8ET1 Expansion I/O Units

Expansion I/O Units can be connected to the CPU Unit to configure the required number of I/O points.

#### ● DC Inputs (CP1W-40EDR/40EDT/40EDT1/20EDR1/20EDT/20EDT1/8ED)

Item	Specifications
Input voltage	24 VDC +10%/-15%
Input impedance	4.7 kΩ
Input current	5 mA typical
ON voltage	14.4 VDC min.
OFF voltage	5.0 VDC max.
ON delay	0 to 32 ms max. (Default: 8 ms) (See note 1.)
OFF delay	0 to 32 ms max. (Default: 8 ms) (See note 1.)
Circuit configuration	

- Note:**
1. Do not apply a voltage exceeding the rated voltage to an input terminal.
  2. Can be set in the PLC Setup to 0, 0.5, 1, 2, 4, 8, 16 or 32 ms. The CP1W-40EDR/EDT/EDT1 are fixed at 16 ms.  
1ms min. (hardware delay value)

#### ● Relay Outputs (CP1W-40EDR/32ER/20EDR1/16ER/8ER)

Item	Specifications	
Max. switching capacity	2 A, 250 VAC (cosφ = 1), 24 VDC 4 A/common	
Min. switching capacity	5 VDC, 10 mA	
Service life of relay	Electrical	Resistive load 150,000 operations (24 VDC)
		Inductive load 100,000 operations (24 VAC cos = 0.4)
	Mechanical	20,000,000 operations
ON delay	15 ms max.	
OFF delay	15 ms max.	
Circuit configuration		

- Note:** There are restrictions in the power supply voltage and output load current imposed by the ambient temperature for CPU Units with DC power. Use the CPU Unit within the following ranges of power supply voltage and output load current. Refer to the CP1L CPU Unit Operation Manual (Cat. No. W462) or the CP Series CP1L-EL/EM CPU Unit Operation Manual (Cat. No. W516).

● Transistor Outputs (Sinking/Sourcing)  
 (CP1W-40EDT/-40EDT1/-32ET/-32ET1/-20EDT/-20EDT1/-16ET/-16ET1/-8ET/-8ET1)

Item	Specifications				
	CP1W-40EDT CP1W-40EDT1	CP1W-32E CP1W-32ET1	CP1W-20EDT CP1W-20EDT1	CP1W-16ET CP1W-16ET1	CP1W-8ET CP1W-8ET1
Max. switching capacity (See note 3.)	4.5 to 30 VDC: 0.3 A/point		24 VAC +10%/-5%: 0.3 A/point	4.5 to 30 VDC: 0.3 A/point	• OUT00/01 4.5 to 30 VDC, 0.2 A/output • OUT02 to 07 4.5 to 30 VDC, 0.3 A/output
	0.9 A/common 3.6 A/Unit	0.9 A/common 7.2 A/Unit	0.9 A/common 1.8 A/Unit	0.9 A/common 3.6 A/Unit	0.9 A/common 1.8 A/Unit
Leakage current	0.1 mA max.				
Residual voltage	1.5 V max.				
ON delay	0.1ms max.				
OFF delay	1 ms max. at 24 VDC +10%/-5%, 5 to 300 mA				
Max. number of Simultaneously ON Points of Output	16 pts (100%)	24 pts (75%)	8 pts (100%)	16 pts (100%)	8 pts (100%)
Fuse (See note 2.)	1/common				
Circuit configuration	Sinking Outputs		Sourcing Outputs		

- Note:**
1. Do not apply a voltage or connect a load to an output terminal exceeding the maximum switching capacity.
  2. The fuses cannot be replaced by the user.
  3. A maximum of 0.9 A per common can be switched at an ambient temperature of 50°C.

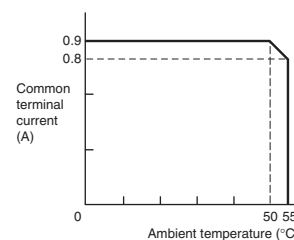

## ■ CP1W-AD041/AD042/DA021/DA041/DA042/MAD11/MAD42/MAD44 Analog Units

Analog values that are input are converted to binary data and stored in the input area, or binary data is output as analog values.

### ● Analog Input Units

Model		CP1W-AD041		CP1W-AD042	
Item		Voltage Input	Current Input	Voltage Input	Current Input
Number of inputs		4 inputs (4 words allocated)			
Input signal range		0 to 5 VDC, 1 to 5 VDC, 0 to 10 VDC, or -10 to 10 VDC	0 to 20 mA or 4 to 20 mA	0 to 5 VDC, 1 to 5 VDC, 0 to 10 VDC, or -10 to 10 VDC	0 to 20 mA or 4 to 20 mA
Max. rated input		±15 V	±30 mA	±15 V	±30 mA
External input impedance		1 MΩ min.	Approx. 250 Ω	1 MΩ min.	Approx. 250 Ω
Resolution		1/6000 (full scale)		1/12000 (full scale)	
Overall accuracy	25°C	0.3% full scale	0.4% full scale	0.2% full scale	0.3% full scale
	0 to 55°C	0.6% full scale	0.8% full scale	0.5% full scale	0.7% full scale
A/D conversion data		16-bit binary (4-digit hexadecimal) Full scale for -10 to 10 V: F448 to 0BB8 Hex Full scale for other ranges: 0000 to 1770 Hex		16-bit binary (4-digit hexadecimal) Full scale for -10 to 10 V: E890 to 1770 Hex Full scale for other ranges: 0000 to 2EE0 Hex	
Averaging function		Supported (Set in output words n+1 and n+2.)			
Open-circuit detection function		Supported			
Conversion time		2 ms/point (8 ms/all points)		1 ms/point (4 ms/all points)	
Isolation method		Photocoupler isolation between analog I/O terminals and internal circuits. No isolation between analog I/O signals.			
Current consumption		5 VDC: 100 mA max.; 24 VDC: 90 mA max.		5 VDC: 80 mA max.; 24 VDC: 40 mA max.	

### ● Analog Output Units

Model		CP1W-DA021/CP1W-DA041		CP1W-DA042		
Item		Voltage Output	Current Output	Voltage Output	Current Output	
Analog output section	Number of outputs	CP1W-DA021: 2 outputs (2 words allocated) CP1W-DA041: 4 outputs (4 words allocated)		4 outputs (4 words allocated)		
	Output signal range	1 to 5 VDC, 0 to 10 VDC, or -10 to 10 VDC	0 to 20 mA or 4 to 20 mA	1 to 5 VDC, 0 to 10 VDC, or -10 to 10 VDC	0 to 20 mA or 4 to 20 mA	
	External output allowable load resistance	2 kΩ min.	350 Ω max.	2 kΩ min.	350 Ω max.	
	External output impedance	0.5 Ω max.	---	0.5 Ω max.	---	
	Resolution	1/6000 (full scale)		1/12000 (full scale)		
	Overall accuracy	25°C	0.4% full scale		0.3% full scale	
		0 to 55°C	0.8% full scale		0.7% full scale	
D/A conversion data		16-bit binary (4-digit hexadecimal) Full scale for -10 to 10 V: F448 to 0BB8 Hex Full scale for other ranges: 0000 to 1770 Hex		16-bit binary (4-digit hexadecimal) Full scale for -10 to 10 V: E890 to 1770 Hex Full scale for other ranges: 0000 to 2EE0 Hex		
Conversion time		CP1W-DA021: 2 ms/point (4 ms/all points) CP1W-DA041: 2 ms/point (8 ms/all points)		1 ms/point (4 ms/all points)		
Isolation method		Photocoupler isolation between analog I/O terminals and internal circuits. No isolation between analog I/O signals.				
Current consumption		CP1W-DA021: 5 VDC: 40 mA max.; 24 VDC: 95 mA max. CP1W-DA041: 5 VDC: 80 mA max.; 24 VDC: 124 mA max.		5 VDC: 80 mA max.; 24 VDC: 160 mA max.		



## ● Analog I/O Units

Model		CP1W-MAD42/CP1W-MAD44		CP1W-MAD11		
Item		Voltage I/O	Current I/O	Voltage I/O	Current I/O	
Analog Input Section	Number of inputs	4 inputs (4 words allocated)		2 inputs (2 words allocated)		
	Input signal range	0 to 5 VDC, 1 to 5 VDC, 0 to 10 VDC, or -10 to 10 VDC	0 to 20 mA or 4 to 20 mA	0 to 5 VDC, 1 to 5 VDC, 0 to 10 VDC, or -10 to 10 VDC	0 to 20 mA or 4 to 20 mA	
	Max. rated input	±15 V	±30 mA	±15 V	±30 mA	
	External input impedance	1 MΩ min.	Approx. 250 Ω	1 MΩ min.	Approx. 250 Ω	
	Resolution	1/12000 (full scale)		1/6000 (full scale)		
	Overall accuracy	25°C	0.2% full scale	0.3% full scale	0.3% full scale	0.4% full scale
		0 to 55°C	0.5% full scale	0.7% full scale	0.6% full scale	0.8% full scale
	A/D conversion data	16-bit binary (4-digit hexadecimal) Full scale for -10 to 10 V: E890 to 1770 hex Full scale for other ranges: 0000 to 2EE0 hex		16-bit binary (4-digit hexadecimal) Full scale for -10 to 10 V: F448 to 0BB8 hex Full scale for other ranges: 0000 to 1770 hex		
	Averaging function	Supported		Supported (Settable for individual inputs via DIP switch)		
Open-circuit detection function	Supported					
Analog Output Section	Number of outputs	CP1W-MAD42: 2 outputs (2 words allocated) CP1W-MAD44: 4 outputs (4 words allocated)		1 output (1 word allocated)		
	Output signal range	1 to 5 VDC, 0 to 10 VDC, or -10 to 10 VDC	0 to 20 mA or 4 to 20 mA	1 to 5 VDC, 0 to 10 VDC, or -10 to 10 VDC	0 to 20 mA or 4 to 20 mA	
	Allowable external output load resistance	2 kΩ min.	350 Ω max.	1 kΩ min.	600 Ω max.	
	External output impedance	0.5 Ω max.	---	0.5 Ω max.	---	
	Resolution	1/12000 (full scale)		1/6000 (full scale)		
	Overall accuracy	25°C	0.3% full scale		0.4% full scale	
		0 to 55°C	0.7% full scale		0.8% full scale	
Set data (D/A conversion)	16-bit binary (4-digit hexadecimal) Full scale for -10 to 10 V: E890 to 1770 hex Full scale for other ranges: 0000 to 2EE0 hex		16-bit binary (4-digit hexadecimal) Full scale for -10 to 10 V: F448 to 0BB8 hex Full scale for other ranges: 0000 to 1770 hex			
Conversion time	CP1W-MAD42: 1 ms/point (6 ms/all points) CP1W-MAD44: 1 ms/point (8 ms/all points)		2 ms/point (6 ms/all points)			
Isolation method	Photocoupler isolation between analog I/O terminals and internal circuits. No isolation between analog I/O signals.					
Current consumption	CP1W-MAD42: 5 VDC: 90 mA max., 24 VDC: 120 mA max. CP1W-MAD44: 5 VDC: 90 mA max., 24 VDC: 170 mA max.		5 VDC: 83 mA max., 24 VDC: 110 mA max.			

## ■ Temperature Sensor Units: CP1W-TS001/TS002/TS101/TS102

By mounting a Temperature Sensor Unit to the PLC, inputs can be obtained from thermocouples or platinum resistance thermometers, and temperature measurements can be converted to binary data and stored in the input area of the CPU Unit.

Item	CP1W-TS001	CP1W-TS002	CP1W-TS101	CP1W-TS102
	Thermocouples		Platinum resistance thermometer	
Temperature sensors	Switchable between K and J, but same type must be used for all inputs.		Switchable between Pt100 and JPt100, but same type must be used for all inputs.	
Number of inputs	2	4	2	4
Allocated input words	2	4	2	4
Accuracy	(The larger of $\pm 0.5\%$ of converted value or $\pm 2^{\circ}\text{C}$ ) $\pm 1$ digit max. *		(The larger of $\pm 0.5\%$ of converted value or $\pm 1^{\circ}\text{C}$ ) $\pm 1$ digit max.	
Conversion time	250 ms for 2 or 4 input points			
Converted temperature data	16-bit binary data (4-digit hexadecimal)			
Isolation	Photocouplers between all temperature input signals			
Current consumption	5 VDC: 40 mA max., 24 VDC: 59 mA max.		5 VDC: 54 mA max., 24 VDC: 73 mA max.	

\* Accuracy for a K-type sensor at  $-100^{\circ}\text{C}$  or less is  $\pm 4^{\circ}\text{C} \pm 1$  digit max.

The rotary switch is used to set the temperature range.

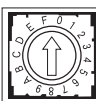
Setting	CP1W-TS001/TS002			CP1W-TS101/TS102			
	Input type	Range ( $^{\circ}\text{C}$ )	Range ( $^{\circ}\text{F}$ )	Input type	Range ( $^{\circ}\text{C}$ )	Range ( $^{\circ}\text{F}$ )	
	0	K	-200 to 1,300	-300 to 2,300	Pt100	-200.0 to 650.0	-300.0 to 1,200.0
	1		0.0 to 500.0	0.0 to 900.0	JPt100	-200.0 to 650.0	-300.0 to 1,200.0
	2	J	-100 to 850	-100 to 1,500	---	Cannot be set.	
	3		0.0 to 400.0	0.0 to 750.0	---		
4 to F	---	Cannot be set.		---			

## ● Main Specifications

Item		CP1W-TS003
Temperature sensors		Thermocouples or analog input *1
		Switchable between K and J, but same type must be used for all inputs.
Number of inputs		4
Accuracy at 25°C	Thermocouple inputs	(The larger of $\pm 0.5\%$ of converted value or $\pm 2^\circ\text{C}$ ) $\pm 1$ digit max. *2
	Analog voltage inputs	0.5% full scale
	Analog inputs	0.6% full scale
Accuracy at 0 to 55°C	Thermocouple inputs	(The larger of $\pm 1\%$ of converted value or $\pm 4^\circ\text{C}$ ) $\pm 1$ digit max. *3
	Analog voltage inputs	1.0 % full scale
	Analog inputs	1.2 % full scale
Input signal range	Thermocouple inputs	K: -200.0 to 1300.0°C or .300.0 to 2300.0°F J: -100.0 to 850.0°C or .100.0 to 1500.0°F
	Analog voltage inputs	0 to 10V/1 to 5V
	Analog inputs	4 to 20mA
Resolution	Thermocouple inputs	0.1°C or 0.1°F
	Analog inputs	1/12000 (full scale)
Max. rated input	Analog voltage inputs	$\pm 15\text{V}$
	Analog inputs	$\pm 30\text{mA}$
External input impedance	Analog voltage inputs	1M $\Omega$ min.
	Analog inputs	Approx. 250 $\Omega$
Open-circuit detection function		Supported
Averaging function		Unsupported
Conversion time		250 ms for 4 input points
Converted temperature data		16-bit binary data (4-digit hexadecimal)
Converted AD data		16-bit binary data (4-digit hexadecimal)
Isolation		Photocouplers between all temperature and analog input signals
Current consumption		5 VDC: 70 mA max., 24 VDC: 30 mA max.

\*1 Only last two channels can be used as analog input.

\*2 Accuracy for a K-type sensor at -100°C or less is  $\pm 4^\circ\text{C} \pm 1$  digit max.

\*3 Accuracy for a K-type sensor at -100°C or less is  $\pm 10^\circ\text{C} \pm 1$  digit max.

## DIP Switch Settings

The DIP switch is used to set the input type (temperature or analog input), the input thermocouple type (K or J) and the temperature unit ( $^\circ\text{C}$  or  $^\circ\text{F}$ ).

**Note:** Set the temperature range according to the type of temperature sensor connected to the Unit. Temperature data will not be converted correctly if the temperature range does not match the sensor.

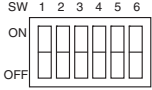
SW		Setting	
	1	Thermocouple type of temperature sensor	ON: J OFF: K
	2	Temperature unit	ON: $^\circ\text{F}$ OFF: $^\circ\text{C}$
	3	NC	
	4	Input type selection for the third input (Input 2)	ON: Analog input OFF: Thermocouple
	5	Input type selection for the fourth input (Input 3)	ON: Analog input OFF: Thermocouple
	6	Analog input signal range	ON: 1 to 5V/4 to 20mA OFF: 0 to 10V

Temperature input		
Input type	Range ( $^\circ\text{C}$ )	Range ( $^\circ\text{F}$ )
K	-200.0 to 1300.0	-300 to 2300
J	-100.0 to 850.0	-100.0 to 1500

# CP1L

## ● Main Specifications

Item		CP1W-TS004
Temperature sensors		Thermocouples Switchable between K and J, but same type must be used for all inputs.
Number of inputs		12
Accuracy	25°C	(The larger of ±0.5% of converted value or ±2°C) ±1 digit max. *1
	0 to 55°C	(The larger of ±1% of converted value or ±4°C) ±1 digit max. *2
Conversion time		500 ms for 12 input points
Converted temperature data		16-bit binary data (4-digit hexadecimal) 2-decimal-place mode is not supported
Isolation		Photocouplers between any two input signals
Current consumption		5 VDC: 80 mA max., 24 VDC: 50 mA max.

\*1 Accuracy for a K-type sensor at -100°C or less is ±4°C ±1 digit max.

\*2 Accuracy for a K-type sensor at -100°C or less is ±10°C ±1 digit max.

## DIP Switch Settings

The DIP switch is used to set the temperature unit and to set the temperature input range.

**Note:** Set the temperature range according to the type of temperature sensor connected to the Unit. Temperature data will not be converted correctly if the temperature range does not match the sensor.

SW		Setting		
	1	Input type	ON	J
			OFF	K
	2	Temperature unit	ON	°F
			OFF	°C

Temperature input		
Input type	Range (°C)	Range (°F)
K	-200.0 to 1300.0	-300 to 2300
J	-100.0 to 850.0	-100.0 to 1500

## ■ CP1W-SRT21 CompoBus/S I/O Link Unit

The CompoBus/S I/O Link Unit functions as a slave for a CompoBus/S Master Unit (or an SRM1 CompoBus/S Master Control Unit) to form an I/O Link with 8 inputs and 8 outputs between the CompoBus/S I/O Link Unit and the Master Unit.

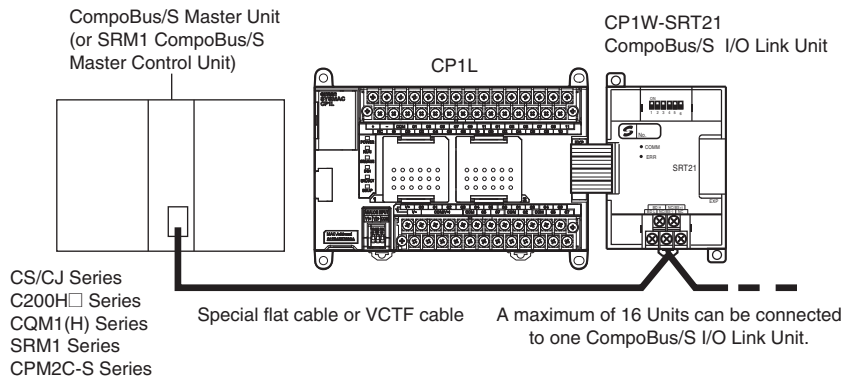

## ● Specifications

Item	Model	CP1W-SRT21
Master/Slave		CompoBus/S Slave
Number of I/O bits		8 input bits, 8 output bits
Number of words occupied in CP1L I/O memory		1 input word, 1 output word (Allocated in the same way as for other Expansion Units)
Node number setting		Set using the DIP switch (before the CPU Unit is turned ON.)

## I/O Bits and I/O Allocations

With CP1L CPU Units, the beginning input and output words (CIO 0 and CIO 100) are allocated by the CPU Unit one or two words at a time. I/O bits are allocated in word units in order of connection to Expansion Units and Expansion I/O Units connected to a CPU Unit.

CPU Unit	Allocated words	
	Inputs	Outputs
CP1L CPU Unit with 10, 14, or 20 I/O points	CIO 0	CIO 100
CP1L CPU Unit with 30 or 40 I/O points	CIO 0 and CIO 1	CIO 100 and CIO 101
CP1L CPU Unit with 60 I/O points	CIO 0, CIO 1, and CIO 2	CIO 100, CIO 101, and CIO102

### ● Example: I/O Bit Allocations When Expansion Units Are Connected

CP1L CPU Unit with 40 I/O Points + Temperature Sensor Unit + Analog Output Unit + Expansion I/O Unit with 40 I/O Points

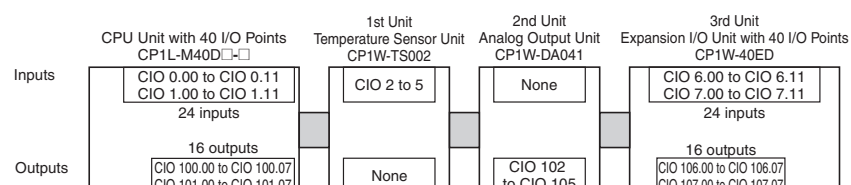

## The Number of the Maximum Connect of Expansion Unit

### ■ Maximum Number of CP1W/CPM1A Expansion Unit and Expansion I/O Units

#### ● CP1L (EM, M) CPU Units

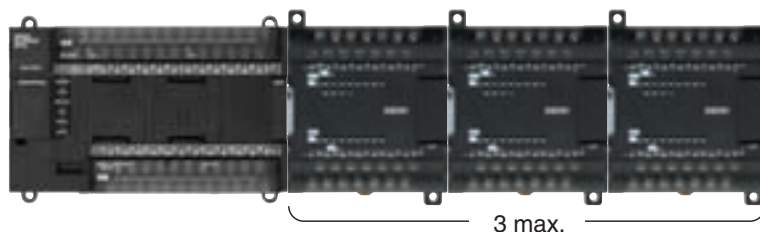

#### ● CP1L (EL) CPU Units or CP1L (L) CPU Units with 20 or 14 Points

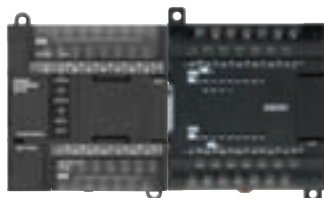

1 max. Note: CP1L (L Type) CPU Units with 10 points do not support Expansion Units.

# CP1L

## Dimensions

(Unit: mm)

### ■ CPU Units

#### CP1L-EM CPU Units with 40 Points

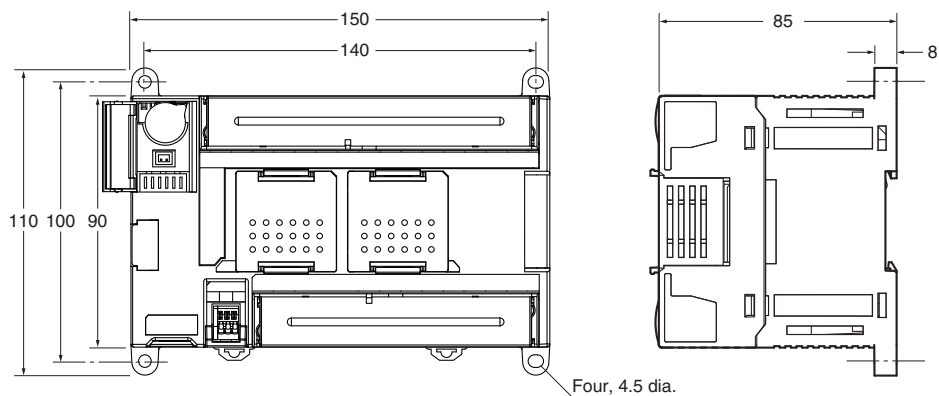

Weight:  
675 g max.

#### CP1L-EM CPU Units with 30 Points

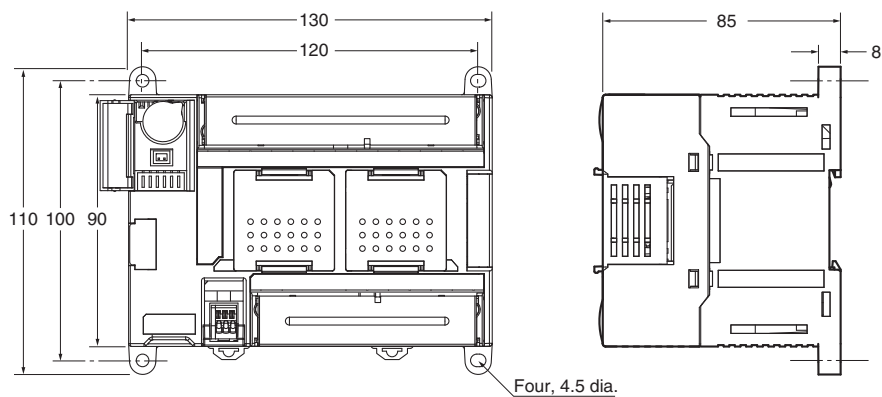

Weight:  
610 g max.

#### CP1L-EL CPU Units with 20 Points

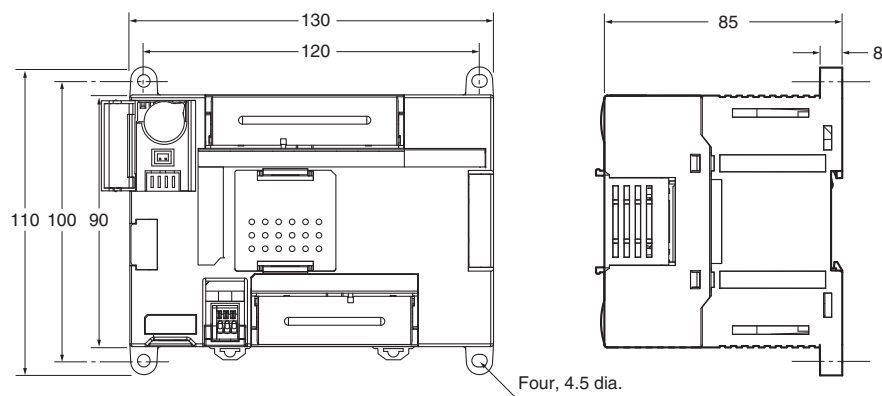

Weight:  
610 g max.

**CP1L CPU Units with 60 I/O Points**

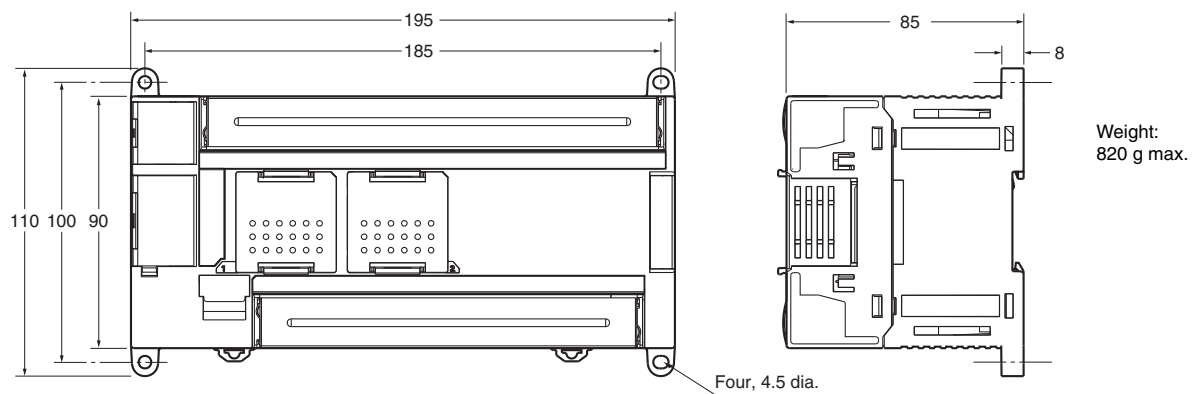

**CP1L CPU Units with 40 I/O Points**

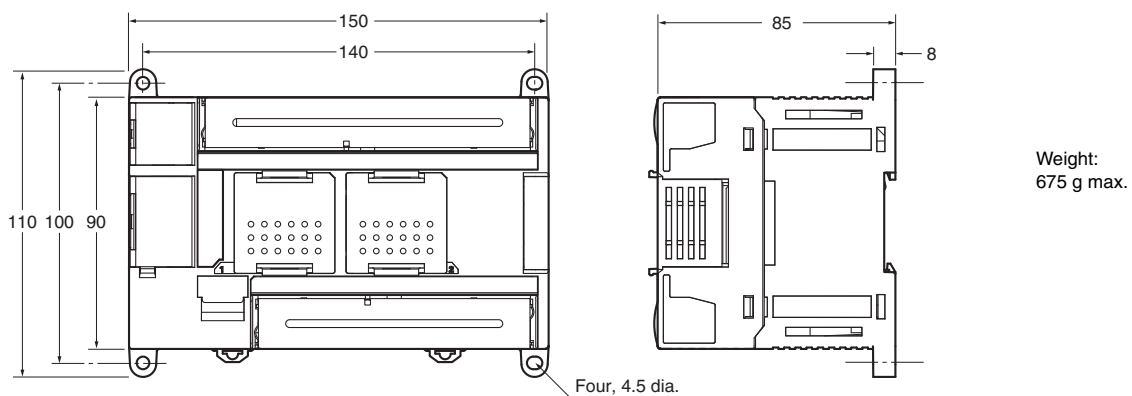

**CP1L CPU Units with 30 I/O Points**

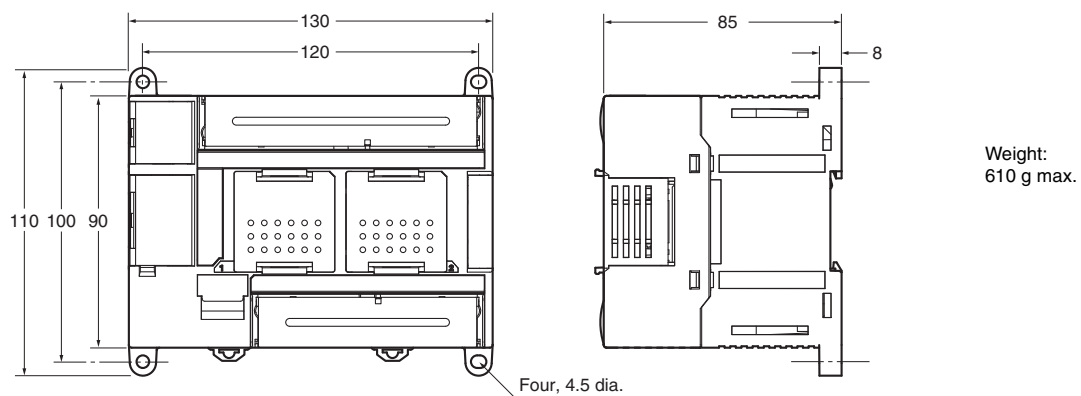

# CP1L

## CP1L CPU Units with 14 or 20 I/O Points

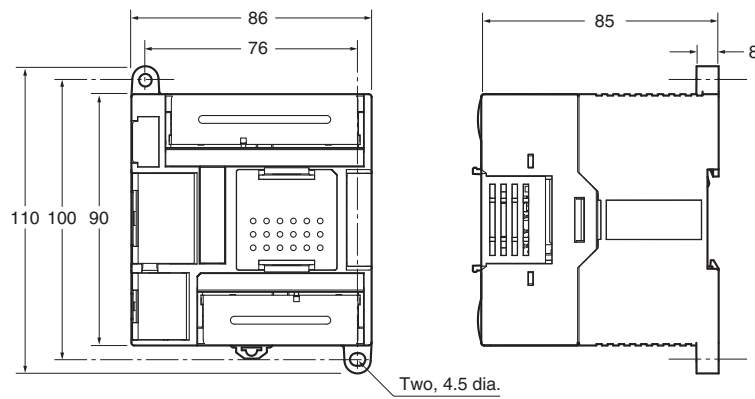

## CP1L CPU Units with 10 I/O Points

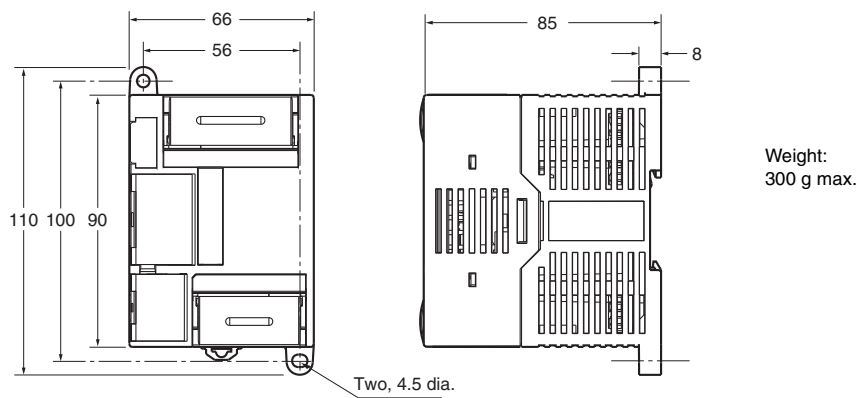



■ Expansion Units and Expansion I/O Units

CP1W-20ED□□, CP1W-16E□□,  
 CP1W-AD04□, CP1W-DA021/04□,  
 CP1W-MAD□□, CP1W-TS□□1/□□2/□□3

CP1W-8E□□  
 CP1W-SRT21

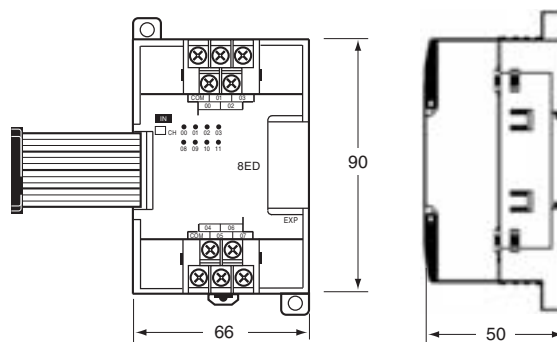
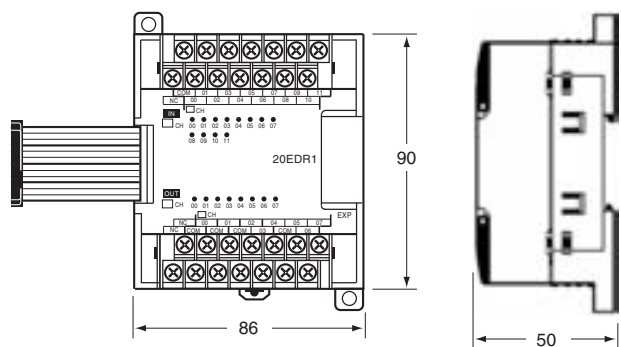

CP1W-40ED□  
 CP1W-32E□□  
 CP1W-TS004

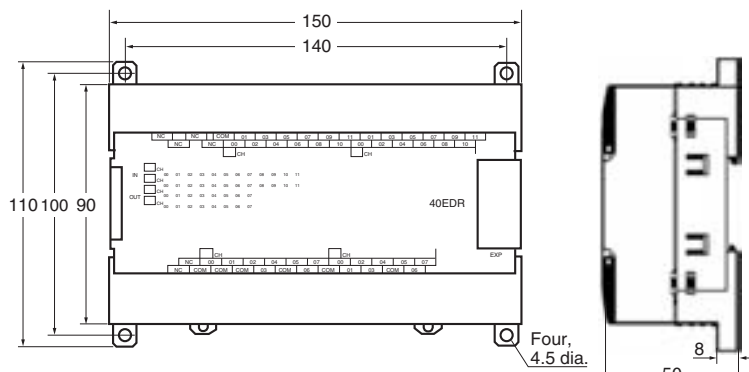

Unit name	Model number	Weight
Expansion I/O Units	CP1W-40ER	380 g
	CP1W-40EDT/-40EDT1	320 g
	CP1W-32ER	465 g
	CP1W-32ET/-32ET1	325 g
	CP1W-20EDR1/-20EDT/-20EDT1	300 g
	CP1W-16ER	280 g
	CP1W-16ET/-16ET1	225 g
	CP1W-8ED	200 g
Analog Units	CP1W-8ER/-8ET/-8ET1	250 g
	CP1W-AD041/-DA041/-DA021	200 g
	CP1W-AD042/-DA042	250 g
	CP1W-MAD11	150 g
Temperature Sensor Units	CP1W-MAD44/-MAD42	250 g
	CP1W-TS001/-TS002/-TS101/-TS102	250 g
	CP1W-TS003	240 g
CompoBus/S I/O Link Unit	CP1W-TS004	570 g
	CP1W-SRT21	200 g

# CP1L

## Related Manuals

Cat. No.	Model numbers	Manual name	Description
W516	CP1L-EL20D□-□ CP1L-EM30D□-□ CP1L-EM40D□-□	CP Series CP1L-EL/EM CPU Unit Operation Manual	Provides the following information on the CP Series: <ul style="list-style-type: none"> <li>• Overview, design, installation, maintenance, and other basic specifications</li> <li>• Features</li> <li>• System configuration</li> <li>• Mounting and wiring</li> <li>• I/O memory allocation</li> <li>• Troubleshooting</li> </ul> Use this manual together with the <i>CP1H Programmable Controllers Programming Manual (W451)</i> .
W462	CP1L-L10D□-□ CP1L-L14D□-□ CP1L-L20D□-□ CP1L-M30D□-□ CP1L-M40D□-□ CP1L-M60D□-□	CP Series CP1L CPU Unit Operation Manual	Provides the following information on programming the CP Series: <ul style="list-style-type: none"> <li>• Programming methods</li> <li>• Tasks</li> <li>• Programming instructions</li> </ul>
W451	CP1H-X40D□-□ CP1H-XA40D□-□ CP1H-Y20DT-D CP1L-L10D□-□ CP1L-L14D□-□ CP1L-L20D□-□ CP1L-M30D□-□ CP1L-M40D□-□ CP1L-M60D□-□	CP Series CP1H/CP1L CPU Unit Programming Manual	Describes basic setup methods of CP1L PLCs: <ul style="list-style-type: none"> <li>• Basic configuration and component names</li> <li>• Mounting and wiring</li> <li>• Programming, data transfer, and debugging using the CX-Programmer</li> <li>• Application program examples</li> </ul>
W461	CP1L-L10D□-□ CP1L-L14D□-□ CP1L-L20D□-□ CP1L-M30D□-□ CP1L-M40D□-□ CP1L-M60D□-□	CP Series CP1L CPU Unit Introduction Manual	Describes the communications commands used with CS-series, CJ-series, and CP-series PLCs and NSJ Controllers.
W342	SYSMAC CS/CJ/CP/NSJ Series CS1G/H-CPU□□-EV1, CS1G/H-CPU□□H, CS1D-CPU□□H, CS1D-CPU□□S, CJ1H-CPU□□H-R, CJ1G-CPU□□, CJ1M-CPU□□, CJ1G-CPU□□P, CJ1G/H-CPU□□H, CJ2H-CPU6□-EIP, CJ2H-CPU6□, CJ2M-CPU□□, CS1W-SCU□□-V1, CS1W-SCB□□-V1, CJ1W-SCU□□-V1, CP1H-X□□□□-□, CP1H-XA□□□□-□, CP1H-Y□□□□-□, CP1L-M/L□□□□-□, CP1E-E□□□□-□, CP1E-N□□□□-□, NSJ□-□□□□(B)-G5D, NSJ□-□□□□(B)-M3D	CS/CJ/CP/NSJ Series Communications Commands REFERENCE MANUAL	Describes the communications commands used with CS-series, CJ-series, and CP-series PLCs and NSJ Controllers.

# Terms and Conditions Agreement

## **Read and understand this catalog.**

Please read and understand this catalog before purchasing the products. Please consult your OMRON representative if you have any questions or comments.

## **Warranties.**

- (a) Exclusive Warranty. Omron's exclusive warranty is that the Products will be free from defects in materials and workmanship for a period of twelve months from the date of sale by Omron (or such other period expressed in writing by Omron). Omron disclaims all other warranties, express or implied.
- (b) Limitations. OMRON MAKES NO WARRANTY OR REPRESENTATION, EXPRESS OR IMPLIED, ABOUT NON-INFRINGEMENT, MERCHANTABILITY OR FITNESS FOR A PARTICULAR PURPOSE OF THE PRODUCTS. BUYER ACKNOWLEDGES THAT IT ALONE HAS DETERMINED THAT THE PRODUCTS WILL SUITABLY MEET THE REQUIREMENTS OF THEIR INTENDED USE.

Omron further disclaims all warranties and responsibility of any type for claims or expenses based on infringement by the Products or otherwise of any intellectual property right. (c) Buyer Remedy. Omron's sole obligation hereunder shall be, at Omron's election, to (i) replace (in the form originally shipped with Buyer responsible for labor charges for removal or replacement thereof) the non-complying Product, (ii) repair the non-complying Product, or (iii) repay or credit Buyer an amount equal to the purchase price of the non-complying Product; provided that in no event shall Omron be responsible for warranty, repair, indemnity or any other claims or expenses regarding the Products unless Omron's analysis confirms that the Products were properly handled, stored, installed and maintained and not subject to contamination, abuse, misuse or inappropriate modification. Return of any Products by Buyer must be approved in writing by Omron before shipment. Omron Companies shall not be liable for the suitability or unsuitability or the results from the use of Products in combination with any electrical or electronic components, circuits, system assemblies or any other materials or substances or environments. Any advice, recommendations or information given orally or in writing, are not to be construed as an amendment or addition to the above warranty.

See <http://www.omron.com/global/> or contact your Omron representative for published information.

## **Limitation on Liability; Etc.**

OMRON COMPANIES SHALL NOT BE LIABLE FOR SPECIAL, INDIRECT, INCIDENTAL, OR CONSEQUENTIAL DAMAGES, LOSS OF PROFITS OR PRODUCTION OR COMMERCIAL LOSS IN ANY WAY CONNECTED WITH THE PRODUCTS, WHETHER SUCH CLAIM IS BASED IN CONTRACT, WARRANTY, NEGLIGENCE OR STRICT LIABILITY.

Further, in no event shall liability of Omron Companies exceed the individual price of the Product on which liability is asserted.

## **Suitability of Use.**

Omron Companies shall not be responsible for conformity with any standards, codes or regulations which apply to the combination of the Product in the Buyer's application or use of the Product. At Buyer's request, Omron will provide applicable third party certification documents identifying ratings and limitations of use which apply to the Product. This information by itself is not sufficient for a complete determination of the suitability of the Product in combination with the end product, machine, system, or other application or use. Buyer shall be solely responsible for determining appropriateness of the particular Product with respect to Buyer's application, product or system. Buyer shall take application responsibility in all cases.

NEVER USE THE PRODUCT FOR AN APPLICATION INVOLVING SERIOUS RISK TO LIFE OR PROPERTY OR IN LARGE QUANTITIES WITHOUT ENSURING THAT THE SYSTEM AS A WHOLE HAS BEEN DESIGNED TO ADDRESS THE RISKS, AND THAT THE OMRON PRODUCT(S) IS PROPERLY RATED AND INSTALLED FOR THE INTENDED USE WITHIN THE OVERALL EQUIPMENT OR SYSTEM.

## **Programmable Products.**

Omron Companies shall not be responsible for the user's programming of a programmable Product, or any consequence thereof.

## **Performance Data.**

Data presented in Omron Company websites, catalogs and other materials is provided as a guide for the user in determining suitability and does not constitute a warranty. It may represent the result of Omron's test conditions, and the user must correlate it to actual application requirements. Actual performance is subject to the Omron's Warranty and Limitations of Liability.

## **Change in Specifications.**

Product specifications and accessories may be changed at any time based on improvements and other reasons. It is our practice to change part numbers when published ratings or features are changed, or when significant construction changes are made. However, some specifications of the Product may be changed without any notice. When in doubt, special part numbers may be assigned to fix or establish key specifications for your application. Please consult with your Omron's representative at any time to confirm actual specifications of purchased Product.

## **Errors and Omissions.**

Information presented by Omron Companies has been checked and is believed to be accurate; however, no responsibility is assumed for clerical, typographical or proofreading errors or omissions.

**Note: Do not use this document to operate the Unit.**

**OMRON Corporation Industrial Automation Company**  
Tokyo, JAPAN

**Contact: [www.ia.omron.com](http://www.ia.omron.com)**

***Regional Headquarters***

**OMRON EUROPE B.V.**

Wegalaan 67-69-2132 JD Hoofddorp  
The Netherlands  
Tel: (31)2356-81-300/Fax: (31)2356-81-388

**OMRON ELECTRONICS LLC**

One Commerce Drive Schaumburg,  
IL 60173-5302 U.S.A.  
Tel: (1) 847-843-7900/Fax: (1) 847-843-7787

**OMRON ASIA PACIFIC PTE. LTD.**

No. 438A Alexandra Road # 05-05/08 (Lobby 2),  
Alexandra Technopark,  
Singapore 119967  
Tel: (65) 6835-3011/Fax: (65) 6835-2711

**OMRON (CHINA) CO., LTD.**

Room 2211, Bank of China Tower,  
200 Yin Cheng Zhong Road,  
PuDong New Area, Shanghai, 200120, China  
Tel: (86) 21-5037-2222/Fax: (86) 21-5037-2200

**Authorized Distributor:**

© OMRON Corporation 2012-2014 All Rights Reserved.  
In the interest of product improvement,  
specifications are subject to change without notice.

**Cat. No. P081-E1-02**

Printed in Japan  
1214 (0312)